

CONTENUTO INDICE

6	INTRODUZIONE / INTRO
10	RETE DI VENDITA
12	SEZIONI TRASVERSALI
14	OSSERVAZIONI
18	FLOPER / FLOPER
76	SKYLINE / SKYLINE
82	FORMULA / FORMULA
90	CASSETTE EPS// LON / CASSETTE EPS// LON
92	CASSETTE HORIZON / CASSETTE HORIZON
94	RIDO/ RIDO
100	SWIFT BARS / BARA SWIFT
106	PERGOLA LYDIA / PERGOLA LYDIA
108	SISTEMA DI TENDE A TENDALINO
110	SISTEMI DI FINESTRE
118	PULIZIA E MANUTENZIONE
GARANZIA 120	
121	AVVERTENZE DI SICUREZZA
122	MODULI D' ORDINE

FATTO PER IL MONDO

ALBANIA

AUSTRALIA

BULGARIA

CANADA

CHILE

CINA

CIPRO

REPUBBLICA CECA

EGITTO

GEORGIA

GERMANIA

GRECIA

INDIA

INDONESIA

IRAQ

ISRAELE

ITALIA

GIAPPONE

LIBANO

MALTA

MAROCCO

PAESI BASSI

NUOVA ZELANDA

OMAN

ROMANIA

RUSSIA

ARABIA SAUDITA

SERBIA

SKOPJE

SLOVENIA

SPAGNA

TACCHINO

Regno Unito

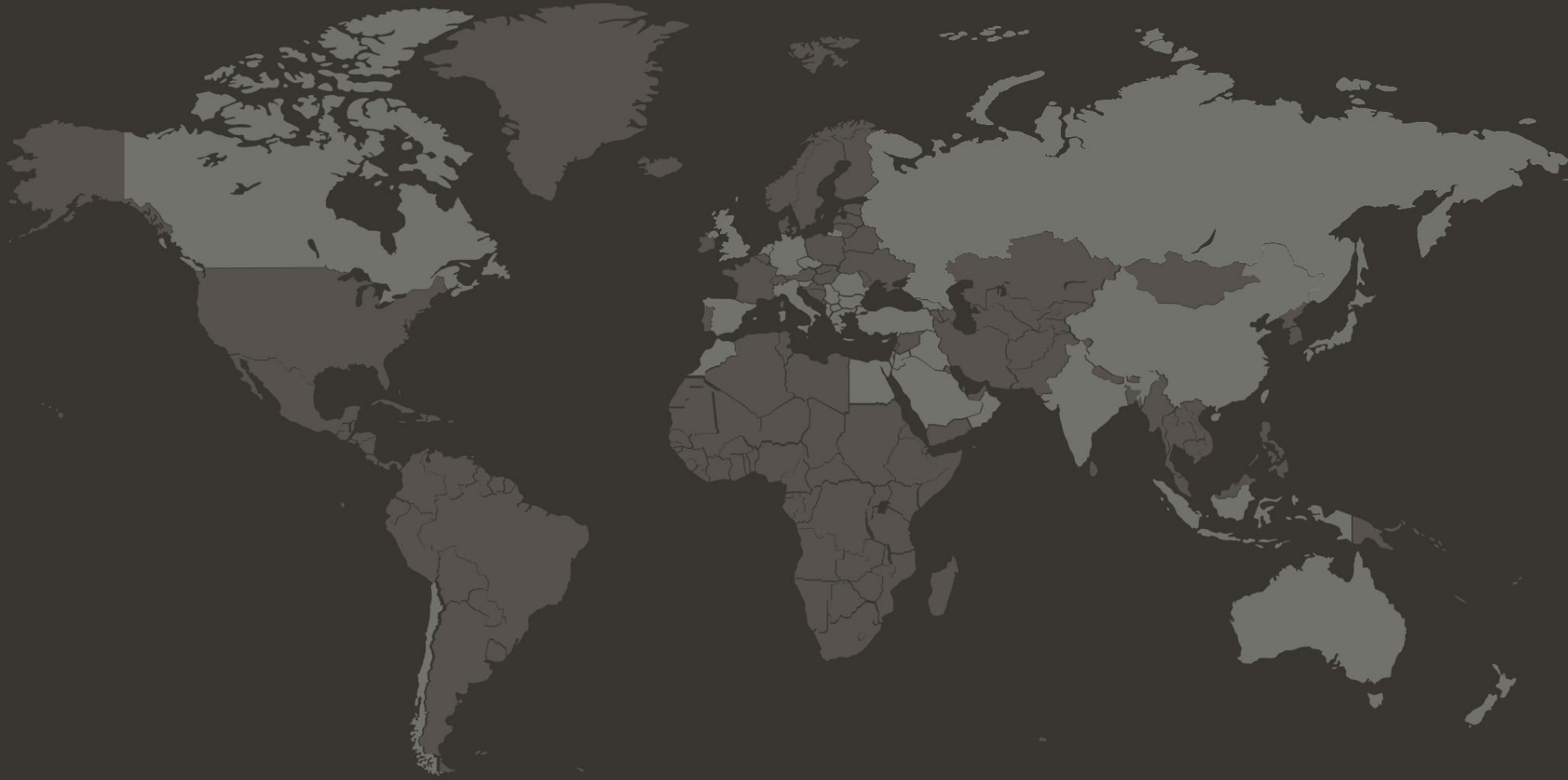

SEZIONI TRASVERSALI

LE SEZIONI SI RIFERISCONO A PERGOLE FLOPER E BIOCLIMATICA

LE SEZIONI TRASVERSALI SI RIFERISCONO A PERGOLE FLOPER E BIOCLIMATICA

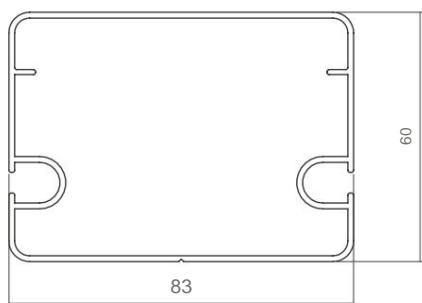

■ **320902**
PROFILO ALTERNATIVO DEL CONTRAPPESO
TERMINALE IN ALLUMINIO
PROFILO DELLA BARRA

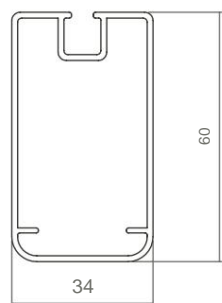

■ **320903**
PROFILO
DEL DADO
DI CONTROLLO IN
ALLUMINIO

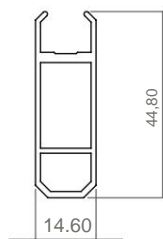

■ **360001**
PROFILO AL.
CURVO
ALLUMINIO
PROFILO CURVA

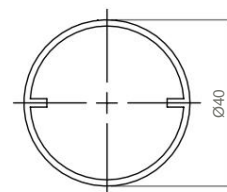

■ **320904**
PROFILO
ALLUMINIO TUBO F40
ALLUMINIO
TUBO PROFILATO Ø40

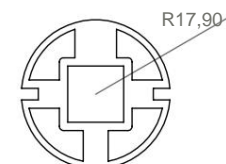

■ **320959**
PROFILO
ALLUMINIO
Ø36
TRASMISSIONE

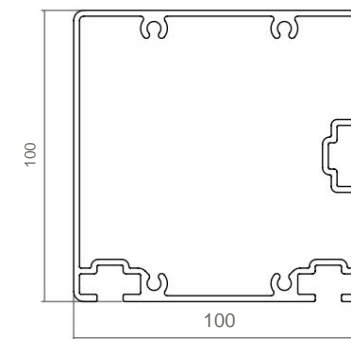

■ **325937**
PROFILO SEZIONE
TRAVERSA ALLUMINIO
TRAVE LATERALE
100X100

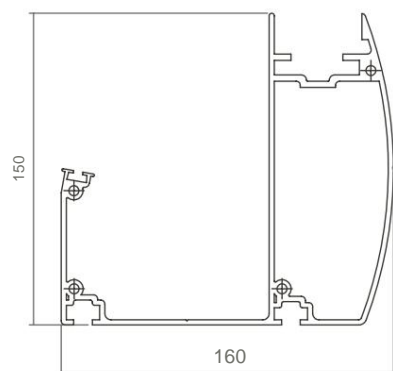

■ **325935**
PROFILO DI DRENAGGIO IN ALLUMINIO
GRONDAIA

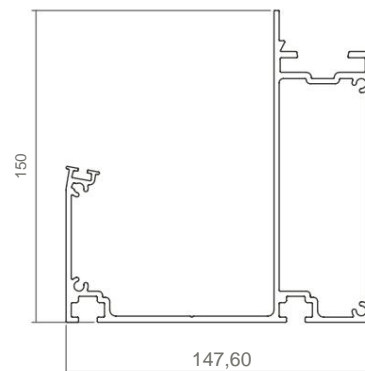

■ **325923**
PROFILO AL. IDRO-FLUSSO RETTILINEO
PROFILO IN ALLUMINIO GRONDAIA DI
DRENAGGIO DRITTA

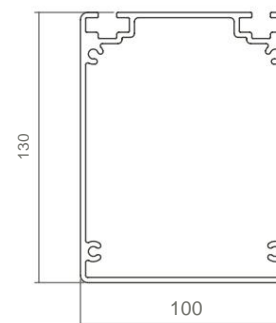

■ **325936**
COLONNA IN PROFILO ALLUMINIO
130X100

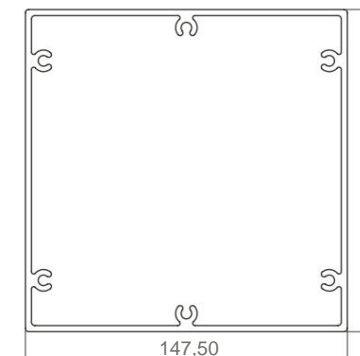

■ **328995**
COLONNA IN PROFILO ALLUMINIO
150X150

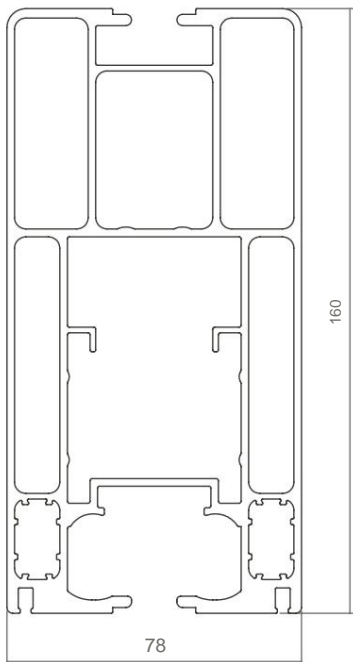

■ 325913
GUIDA FLOPER 160
GUIDA FLOPER 160

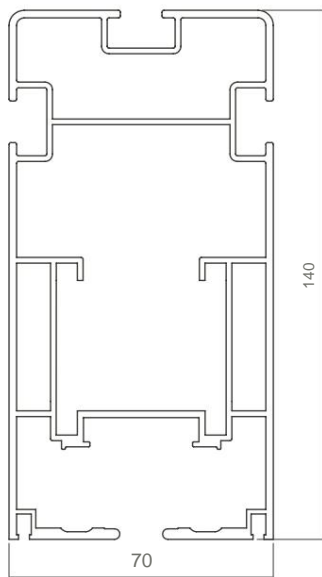

■ 327901
GUIDA FLOPER 140
FLOPER 140 GUIDA

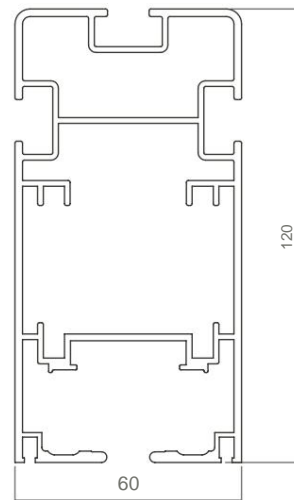

■ 322913
GUIDA FLOPER 120
FLOPER 120 GUIDA

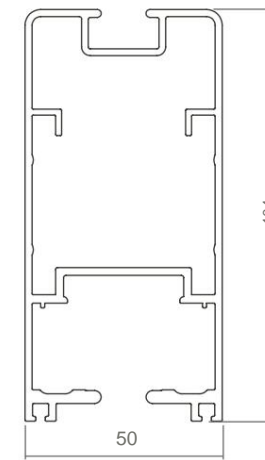

■ 320901
GUIDA FLOPER 100
GUIDA FLOPER 100

■ TRASMISSIONE DEL MOVIMENTO FLOPER
TRASMISSIONE FLOPER



OSSERVAZIONI PER FLOPER

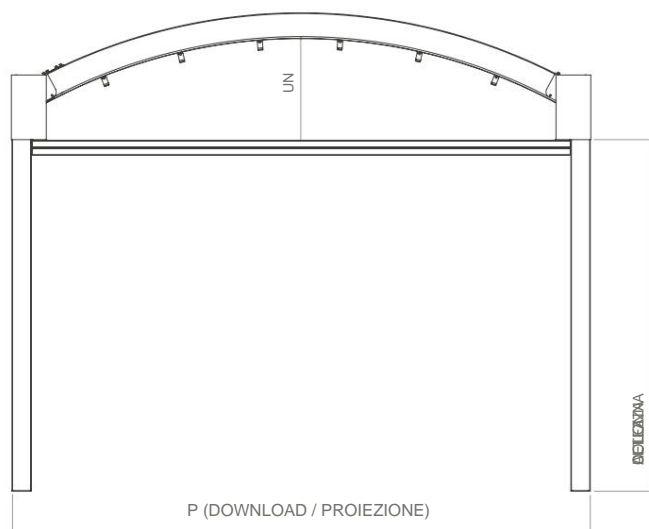
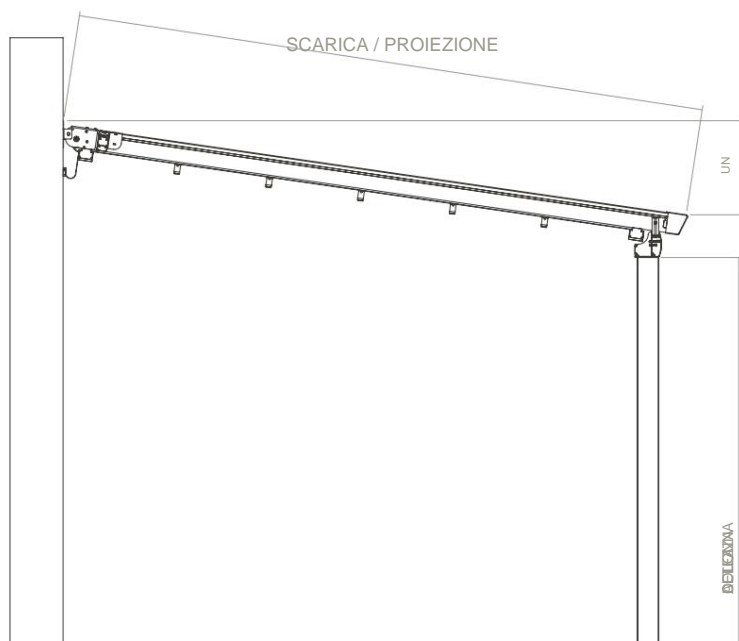

INCLINAZIONE DEL SISTEMA FLOPER		
SCARICA (P) (M) / PROIEZIONE (P) (M)	DADI DI CONTROLLO (PZ.)	UN MIN (M)
2.50	4	0,38
3.00	5	0,45
3.50	5	0,53
4.00	6	0,60
4.50	7	0,68
5.00	8	0,75
5.50	9	0,83
6.00	10	0,90
6.50	11	0,98
7.00	12	1,05
7.50	13	1,13
8.00	14	1,20
8.50	14	1,28
9.00	16	1,36
9.50	16	1,44
10.00	17	1,55

FLOPER SOLID SYSTEM TILT / FLOPER SOLID SYSTEM INCLINAZIONE		
SCARICA (P) (M) / PROIEZIONE (P) (M)	DADI DI CONTROLLO (PZ.)	UN MIN (M)
2.50 - 3,50	4 - 6	0,45
4.00 - 5,50	6 - 10	0,55
6.00 - 7,50	10 - 14	0,60
8.00 - 10,00	14 - 18	0,65

OSSERVAZIONI PER FLOPER

LE PERGOLE FLOPER SI APPLICANO A TUTTE LE PERGOLE FLOPER, TRANNE QUELLE DELLA CATEGORIA SPACE.

LA SEGUENTE TABELLA È APPLICATA A TUTTI I PERGOLATI FLOPER, TRANNE QUELLI DELLA CATEGORIA SPACE

NUMERO DI GUIDE PER SISTEMI FLOPER	
SISTEMI FLOPER	
ASSE (M) / ASSE (M)	GUIDE (PZ.)
2,50 - 4,50	2
4,51 - 9,00	3
9,01 - 13,00	4
13,01 - 15,00	5



POSSIBILITÀ DI SCEGLIERE UN NUMERO PIÙ O MENO DI AUTISTI

POSSIBILITÀ DI SCEGLIERE PIÙ O MENO NUMERO DI GUIDE

NELLE PERGOLE CON PANNELLO A CASCATA E SUPPORTO A PARETE, IL NUMERO DI GUIDE È LO STESSO PER LE COLONNE

PER LE PERGOLE CON GRONDAIA E MONTAGGIO A PARETE IL NUMERO DELLE COLONNE È PARI AL NUMERO DELLE GUIDE

PER LE PERGOLE AUTOPORTANTI A TELAIO, IL NUMERO DI COLONNE È IL DOPPIO DEL NUMERO DI GUIDE

PER LE PERGOLE A TELAIO AUTOPORTANTE IL NUMERO DELLE COLONNE È DOPPIO DEL NUMERO DELLE GUIDE

LE PERGOLE SPACE SONO DOTATE DI 2 GUIDE. 4 COLONNE SONO DOTATE DI ATTACCHI DI BASE CON DISCESA FINO A 5,00 M E 6 COLONNE PER DISCESA DA 5,01 A 7,00 M.

PER LE PERGOLE SPAZIALI SONO POSTE 2 GUIDE. PER LE PERGOLE AUTOPORTANTI CON SPORGENZA FINO A 5,00 M SONO POSTE 4 COLONNE E PER LE PERGOLE DA 5,01 A 7,00 M SONO POSTE 6 COLONNE.

OSSERVAZIONI PER FLOPER

CASI INDICATIVI DI PERGOLE CON DIVERSE LUNGHEZZE DEGLI ASSI
CASI INDICATIVI DI PERGOLE CON DIVERSE LUNGHEZZE DEGLI ASSI

FLOPER 100 CON 4 GUIDE
FLOPER 100 CON 4 GUIDE

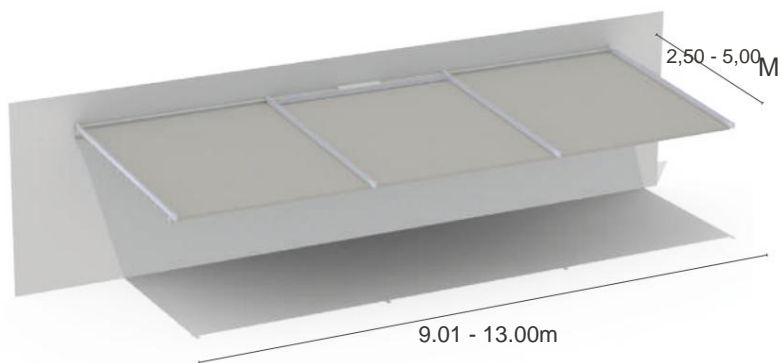

FLOPER 140 CON RINFORZO A 5 GUIDE
FLOPER 140 CON GRONDAIA CON 5 GUIDE

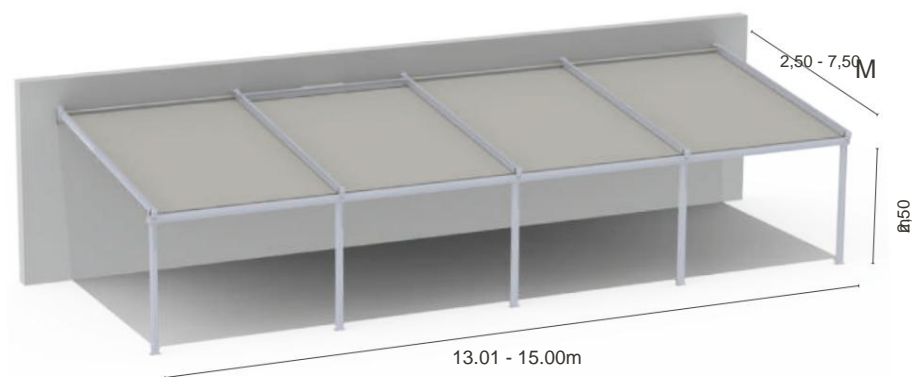

FLOPER 160 CURVA CON RINFORZO A 3 GUIDE
FLOPER 160 CURVA CON GRONDA CON 3 GUIDE

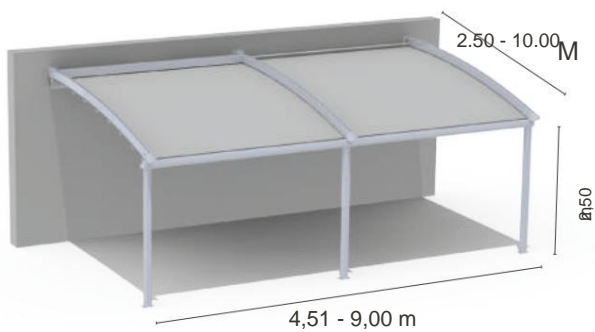

FLOPER 140 TELAIO DRIVER A 4 GUIDE
FLOPER 140 TELAIO AUTOPORTANTE CON 4 GUIDE

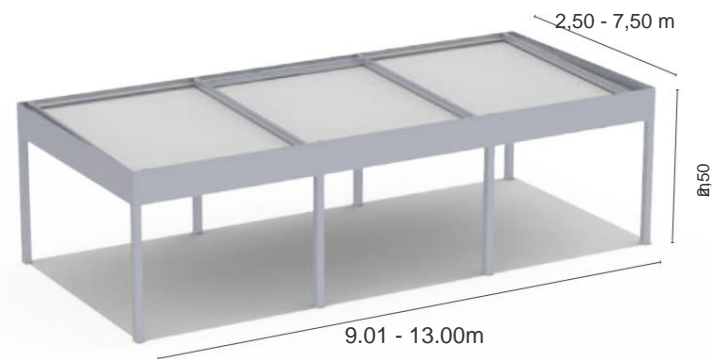

FLOPER 160 SOLID 5-GUIDE AUTOPORTANTE FLOPER
FLOPER 160 SOLID SELF STANDING CON 5 GUIDE

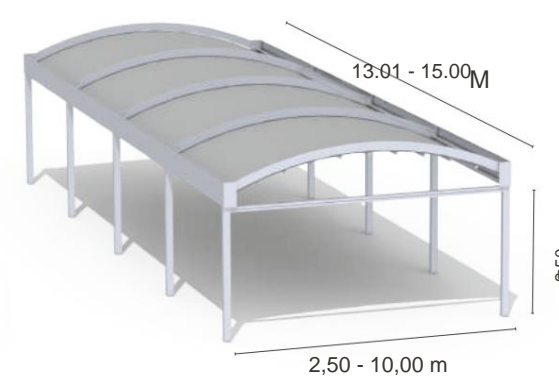

OSSERVAZIONI ILLUMINAZIONE A LED - OSSERVAZIONI LUCI A LED

LA TABELLA SOTTOSTANTE MOSTRA IL NUMERO DI LED IN BASE ALL'ASSE E AL DOWNLOAD SUL FLOPER

LA TABELLA SOTTOSTANTE DESCRIVE LA QUANTITÀ DI LUCI LED IN BASE ALL'ASSE E ALLA PROIEZIONE DEL FLOPER

POSSIBILITÀ DI SCEGLIERE PIÙ O MENO LED

POSSIBILITÀ DI SCEGLIERE PIÙ O MENO NUMERO DI LUCI LED

ASSALE / ASSE	SCARICA / PROIEZIONE															
	2.50	3.00	3.50	4.00	4.50	5.00	5.50	6.00	6.50	7.00	7.50	8.00	8.50	9.00	9.50	10.00
2.50	4	4	6	6	6	6	8	8	8	8	10	10	10	10	10	10
3.00	4	4	6	6	6	6	8	8	8	8	10	10	10	10	10	10
3.50	6	6	9	9	9	9	12	12	12	12	15	15	15	15	15	15
4.00	6	6	9	9	9	9	12	12	12	12	15	15	15	15	15	15
4.50	6	6	9	9	9	9	12	12	12	12	15	15	15	15	15	15
5.00	6	6	9	9	9	9	12	12	12	12	15	15	15	15	15	15
5.50	8	8	12	12	12	12	16	16	16	16	20	20	20	20	20	20
6.00	8	8	12	12	12	12	16	16	16	16	20	20	20	20	20	20
6.50	8	8	12	12	12	12	16	16	16	16	20	20	20	20	20	20
7.00	8	8	12	12	12	12	16	16	16	16	20	20	20	20	20	20
7.50	8	8	15	15	15	15	20	20	20	20	25	25	25	25	25	25
8.00	10	10	15	15	15	15	20	20	20	20	25	25	25	25	25	25
8.50	10	10	15	15	15	15	20	20	20	20	25	25	25	25	25	25
9.00	10	10	15	15	15	15	20	20	20	20	25	25	25	25	25	25
9.50	10	10	18	18	18	18	24	24	24	24	30	30	30	30	30	30
10.00	12	12	18	18	18	18	24	24	24	24	30	30	30	30	30	30
10.50	12	12	18	18	18	18	24	24	24	24	30	30	30	30	30	30
11.00	12	12	18	18	18	18	24	24	24	24	30	30	30	30	30	30
11.50	14	14	21	21	21	21	28	28	28	28	35	35	35	35	35	35
12.00	14	14	21	21	21	21	28	28	28	28	35	35	35	35	35	35
12.50	14	14	21	21	21	21	28	28	28	28	35	35	35	35	35	35
13.00	14	14	21	21	21	21	28	28	28	28	35	35	35	35	35	35
13.50	14	14	21	21	21	21	28	28	28	28	40	40	40	40	40	40
14.00	16	16	24	24	24	24	32	32	32	32	40	40	40	40	40	40
14.50	16	16	24	24	24	24	32	32	32	32	40	40	40	40	40	40
15.00	16	16	24	24	24	24	32	32	32	32	40	40	40	40	40	40



FLOPER 100 PER COSTRUZIONI ESISTENTI

FLOPER 100 PER COSTRUZIONI ESISTENTI

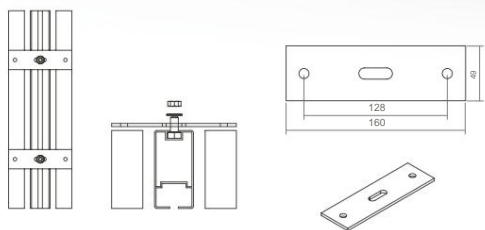
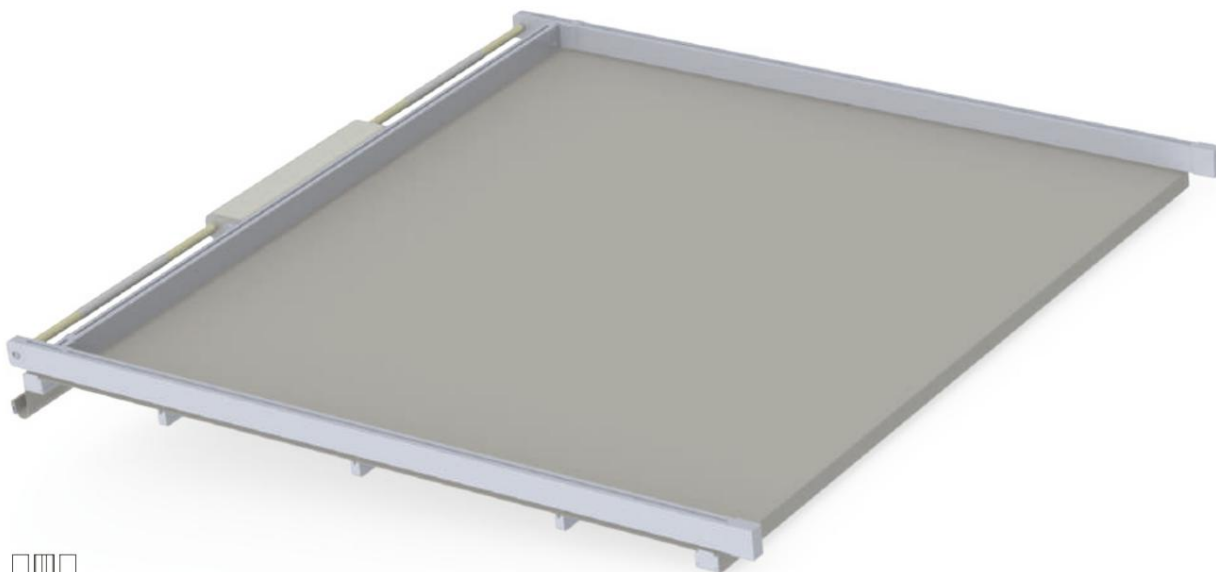

320908A

IL PRIMO MODO PER SUPPORTARE GLI AUTOMOBILISTI
PRIMO MODO PER SOSTENERE LE GUIDE
LAME DI SUPPORTO GUIDA FLOPER
SUPPORTO GUIDA LAME PER FLOPER

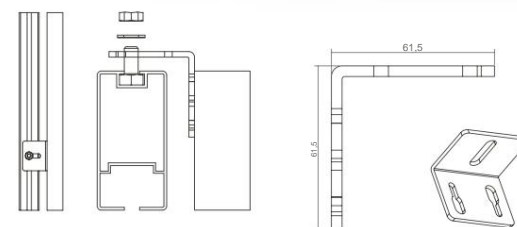
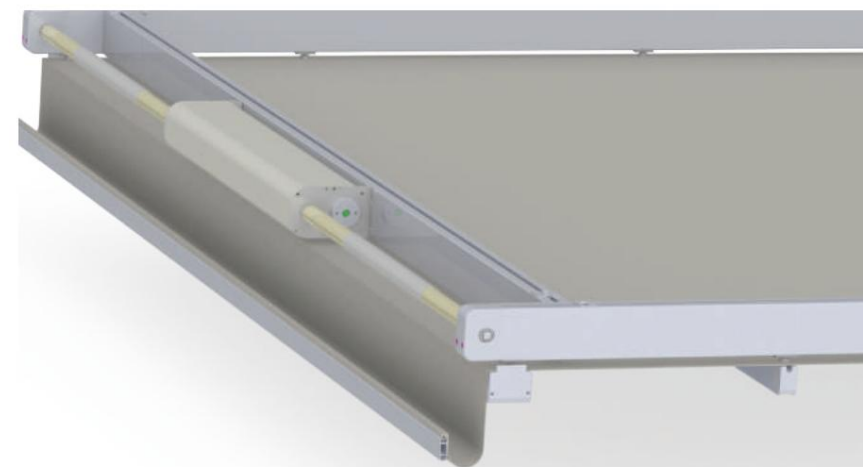

320908B

SECONDO MODO DI SUPPORTARE GLI AUTOMOBILISTI
SECONDO METODO PER SOSTENERE LE GUIDE
ANGOLO DI SUPPORTO GUIDA FLOPER
ANGOLO DI SUPPORTO GUIDA PER FLOPER



MOVIMENTO

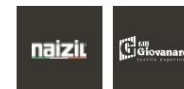
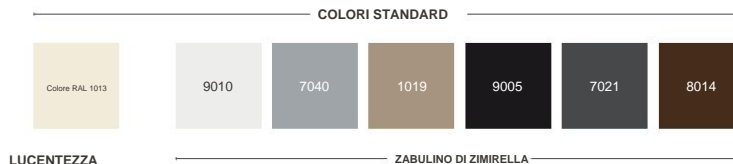

TESSUTI TECNICI



ASSALE / ASSE	SCARICA / PROIEZIONE															
	2.50	3.00	3.50	4.00	4.50	5.00	5.50	6.00	6.50	7.00	7.50	8.00	8.50	9.00	9.50	10.00
2.50	€2.103 y €2.207 y €2.279 y			€2.384 y	€2.489 y €2.593 y €2.698 y €2.803 y €2.990 y					€3.095 y	€3.209 y	€ 3.314 y € 3.386 y € 3.525 y € 3.597 y € 3.699 y				
3.00	€2.192 y €2.307 y €2.384 y			€2.499 y	€2.614 y €2.728 y €2.843 y €2.958 y €3.157 y					€3.290 y	€3.367 y	€ 3.481 y € 3.558 y € 3.712 y € 3.789 y € 3.900 y				
3.50	€2.292 y €2.416 y €2.497 y			€2.621 y	€2.745 y €2.869 y €2.993 y €3.117 y €3.325 y					€3.470 y	€3.556 y	€3.681 y €3.763 y €3.931 y €4.013 y €4.134 y				
4.00	€2.360 y €2.493 y €2.578 y			€2.712 y	€2.845 y €2.978 y €3.111 y €3.245 y €3.461 y					€3.618 y	€3.715 y	€3.849 y €3.936 y €4.119 y €4.206 y €4.337 y				
4.50	€2.459 y €2.601 y €2.691 y			€2.834 y	€2.976 y €3.118 y €3.261 y €3.403 y €3.629 y					€3.798 y	€3.904 y	€4.049 y €4.141 y €4.339 y €4.431 y €4.571 y				
5.00	€2.672 y €2.833 y €2.973 y			€3.154 y	€ 3.335 y € 3.516 y € 3.696 y € 3.961 y € 4.141 y					€4.355 y	€4.480 y	€4.662 y €4.783 y €5.029 y €5.150 y €5.327 y				
5.50	€2.740 y €2.930 y €3.055 y			€3.245 y	€3.435 y €3.625 y €3.815 y €4.088 y €4.278 y					€4.504 y	€4.639 y	€4.831 y €4.988 y €5.218 y €5.345 y €5.531 y				
6.00	€2.808 y €3.008 y €3.136 y			€3.335 y	€3.534 y €3.734 y €3.933 y €4.215 y €4.414 y					€4.653 y	€4.798 y	€5.001 y €5.132 y €5.407 y €5.540 y €5.735 y				
6.50	€2.908 y €3.117 y €3.249 y			€3.458 y	€3.666 y €3.874 y €4.082 y €4.374 y €4.582 y					€4.834 y	€4.989 y	€ 5.202 y € 5.339 y € 5.630 y € 5.768 y € 5.973 y				
7.00	€2.976 y €3.194 y €3.331 y			€3.548 y	€3.766 y €3.983 y €4.284 y €4.501 y €4.719 y					€4.983 y	€5.149 y	€ 5.372 y € 5.514 y € 5.820 y € 5.963 y € 6.178 y				
7.50	€3.079 y €3.311 y €3.452 y			€3.684 y	€3.916 y €4.147 y €4.462 y €4.694 y €4.925 y					€5.209 y	€5.390 y	€ 5.628 y € 5.776 y € 6.107 y € 6.257 y € 6.486 y				
8.00	€3.147 y €3.388 y €3.534 y			€3.775 y	€4.015 y €4.340 y €4.580 y €4.821 y €5.062 y					€5.358 y	€5.549 y	€5.798 y €5.941 y €6.298 y €6.453 y €6.692 y				
8.50	€ 3.246 y € 3.496 y € 3.647 y			€3.897 y	€4.146 y €4.480 y €4.730 y €4.980 y €5.229 y					€5.540 y	€5.741 y	€6.000 y €6.189 y €6.522 y €6.682 y €6.930 y				
9.00	€ 3.314 y € 3.573 y € 3.728 y			€3.987 y	€4.246 y €4.589 y €4.848 y €5.107 y €5.366 y					€5.690 y	€5.901 y	€6.171 y €6.345 y €6.713 y €6.880 y €7.137 y				
9.50	€3.560 y €3.837 y €4.041 y			€4.339 y	€4.720 y €5.017 y €5.315 y €5.612 y €5.910 y					€6.282 y	€6.513 y	€6.822 y €7.016 y €7.443 y €7.640 y €7.935 y				
10.00	€3.628 y €3.934 y €4.123 y			€4.430 y	€4.820 y €5.126 y €5.433 y €5.740 y €6.046 y					€6.432 y	€6.674 y	€6.993 y €7.193 y €7.636 y €7.836 y €8.143 y				
10.50	€3.696 y €4.012 y €4.205 y			€4.604 y	€4.920 y €5.236 y €5.551 y €5.867 y €6.183 y					€6.583 y	€6.836 y	€7.165 y €7.371 y €7.829 y €8.037 y €8.352 y				
11.00	€3.764 y €4.089 y €4.286 y			€4.695 y	€ 5.020 y € 5.345 y € 5.670 y € 5.994 y € 6.319 y					€6.734 y	€6.997 y	€7.337 y €7.549 y €8.022 y €8.237 y €8.561 y				
11.50	€3.832 y €4.166 y €4.368 y			€4.785 y	€5.119 y €5.454 y €5.788 y €6.122 y €6.456 y					€6.885 y	€7.158 y	€7.509 y €7.727 y €8.216 y €8.437 y €8.771 y				
12.00	€3.900 y €4.243 y €4.533 y			€4.876 y	€ 5.220 y € 5.563 y € 5.906 y € 6.249 y € 6.593 y					€7.036 y	€7.320 y	€7.682 y €7.905 y €8.411 y €8.637 y €8.981 y				
12.50	€3.999 y €4.352 y €4.646 y			€4.998 y	€5.351 y €5.703 y €6.055 y €6.408 y €6.760 y					€7.219 y	€7.514 y	€7.886 y €8.116 y €8.637 y €8.870 y €9.223 y				
13.00	€4.067 y €4.429 y €4.727 y			€5.089 y	€ 5.450 y € 5.812 y € 6.174 y € 6.535 y € 6.897 y					€7.371 y	€7.676 y	€8.059 y €8.294 y €8.832 y €9.071 y €9.434 y				
13.50	€4.347 y €4.765 y €5.113 y			€5.536 y	€5.962 y €6.390 y €6.821 y €7.255 y €7.691 y					€8.129 y	€8.461 y	€8.892 y €9.163 y €9.762 y €10.037 y €10.478 y				
14.00	€4.418 y €4.931 y €5.201 y			€5.635 y	€6.072 y €6.512 y €6.954 y €7.399 y €7.848 y					€8.298 y	€8.643 y	€9.087 y €9.365 y €9.982 y €10.265 y €10.720 y				
14.50	€4.524 y €5.053 y €5.329 y			€5.779 y	€6.233 y €6.689 y €7.149 y €7.612 y €8.078 y					€8.547 y	€8.909 y	€9.371 y €9.638 y €10.305 y €10.596 y €11.070 y				
15.00	€4.595 y €5.135 y €5.417 y			€5.878 y	€6.343 y €6.812 y €7.283 y €7.758 y €8.236 y					€8.718 y	€9.093 y	€9.568 y €9.822 y €10.528 y €10.828 y €11.315 y				

I PREZZI INCLUDONO IL MOTORE - DRIVE BOX (SAFETY BOX)

I PREZZI INCLUDONO IL MOTORE (SAFETY BOX)

I PREZZI NON INCLUDONO INSTALLAZIONE E IVA.

I PREZZI NON INCLUDONO INSTALLAZIONE E IVA

MOTORE MOTORE

■ 55/17, 85/17

BEAUFORT

°5 °6 °7 °8 °9 



VERNICE RAL 8% SUL LISTINO PER SCELTA FUORI DAI 7 STANDARD

VERNICE RAL 8% SUL PREZZO DI LISTINO PER SELEZIONE TRA 7 COLORI STANDARD

20 FIORI FINE SHADING

FLOPER 100

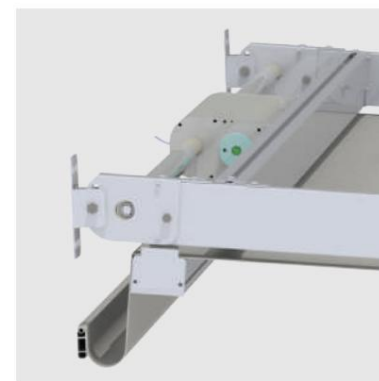
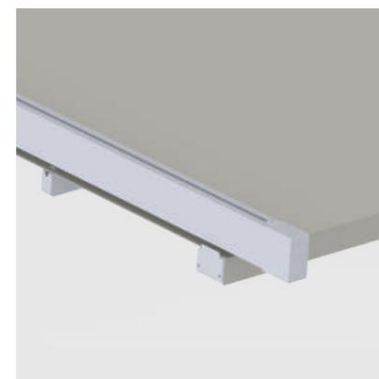
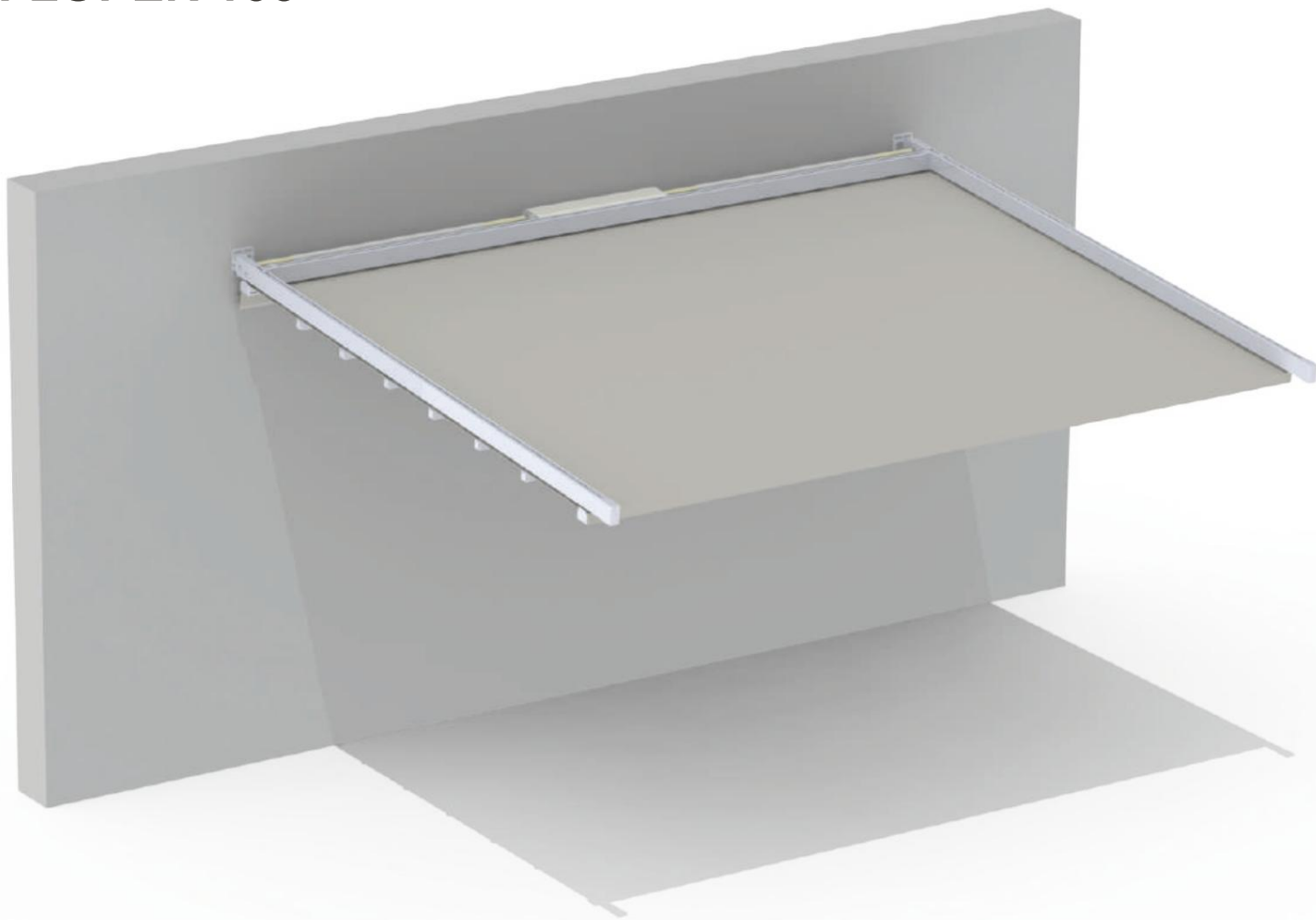

RACCORDI IN METALLO ZINCATO STANDARD
PARTI METALLICHE STANDARD ZINCATE



MOVIMENTO

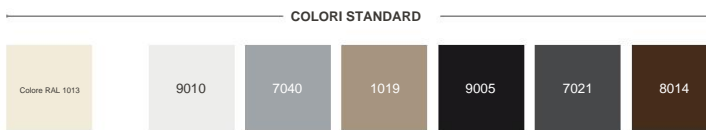

LUCENTEZZA

ZABULINO DI ZIMIRELLA



TESSUTI TECNICI



ASSE / ASSE	SCARICA / PROIEZIONE					
	2.50	3.00	3.50	4.00	4.50	5.00
2.50	€ 2.214y	€ 2.317y	€ 2.388y	€ 2.491y	€ 2.594y	€ 2.725y
3.00	€ 2.280y	€ 2.392y	€ 2.468y	€ 2.580y	€ 2.692y	€ 2.832y
3.50	€ 2.378y	€ 2.499y	€ 2.578y	€ 2.699y	€ 2.820y	€ 2.971y
4.00	€ 2.444y	€ 2.574y	€ 2.658y	€ 2.788y	€ 2.918y	€ 3.079y
4.50	€ 2.541y	€ 2.680y	€ 2.768y	€ 2.907y	€ 3.046y	€ 3.217y
5.00	€ 2.805y	€ 2.982y	€ 3.099y	€ 3.275y	€ 3.452y	€ 3.665y
5.50	€ 2.872y	€ 3.057y	€ 3.178y	€ 3.364y	€ 3.549y	€ 3.772y
6.00	€ 2.938y	€ 3.132y	€ 3.258y	€ 3.452y	€ 3.647y	€ 3.880y
6.50	€ 3.042y	€ 3.245y	€ 3.375y	€ 3.579y	€ 3.813y	€ 4.018y
7.00	€ 3.114y	€ 3.327y	€ 3.462y	€ 3.697y	€ 3.912y	€ 4.126y
7.50	€ 3.215y	€ 3.442y	€ 3.588y	€ 3.831y	€ 4.059y	€ 4.288y
8.00	€ 3.282y	€ 3.518y	€ 3.675y	€ 3.920y	€ 4.158y	€ 4.477y
8.50	€ 3.379y	€ 3.646y	€ 3.794y	€ 4.040y	€ 4.287y	€ 4.615y
9.00	€ 3.473y	€ 3.729y	€ 3.882y	€ 4.138y	€ 4.394y	€ 4.732y
9.50	€ 3.780y	€ 4.074y	€ 4.257y	€ 4.551y	€ 4.928y	€ 5.223y
10.00	€ 3.855y	€ 4.159y	€ 4.346y	€ 4.650y	€ 5.037y	€ 5.341y
10.50	€ 3.930y	€ 4.244y	€ 4.436y	€ 4.833y	€ 5.147y	€ 5.460y
11.00	€ 4.006y	€ 4.329y	€ 4.526y	€ 4.933y	€ 5.256y	€ 5.580y
11.50	€ 4.081y	€ 4.415y	€ 4.616y	€ 5.033y	€ 5.366y	€ 5.700y
12.00	€ 4.158y	€ 4.501y	€ 4.790y	€ 5.134y	€ 5.477y	€ 5.820y
12.50	€ 4.265y	€ 4.618y	€ 4.913y	€ 5.266y	€ 5.619y	€ 5.972y
13.00	€ 4.342y	€ 4.705y	€ 5.004y	€ 5.367y	€ 5.730y	€ 6.093y
13.50	€ 4.655y	€ 5.057y	€ 5.387y	€ 5.789y	€ 6.191y	€ 6.594y
14.00	€ 4.732y	€ 5.229y	€ 5.480y	€ 5.892y	€ 6.304y	€ 6.716y
14.50	€ 4.845y	€ 5.357y	€ 5.613y	€ 6.040y	€ 6.468y	€ 6.895y
15.00	€ 4.921y	€ 5.443y	€ 5.704y	€ 6.141y	€ 6.579y	€ 7.016y

I PREZZI INCLUDONO IL MOTORE - DRIVE BOX (SAFETY BOX)

I PREZZI INCLUDONO IL MOTORE (SAFETY BOX)

I PREZZI NON INCLUDONO INSTALLAZIONE E IVA.

I PREZZI NON INCLUDONO INSTALLAZIONE E IVA

PER LA SCELTA DELL'ACCIAIO INOX, MAGGIORAZIONE DEL 4% SUL PREZZO DI LISTINO

PER PARTI INOX AGGIUNTA DEL 4% SUL PREZZO DI LISTINO

MOTORE MOTORE

■ 55/17, 85/17

BEAUFORT

°5 °6 °7 °8 °9 



VERNICE RAL 8% SUL

**LISTINO PER SCELTA FUORI DAI
7 STANDARD**

VERNICE RAL 8% SUL PREZZO DI LISTINO

PER LA SELEZIONE TRA 7 STANDARD

FLOPER 100 CON SENO

FLOPER 100 CON GRONDAIA

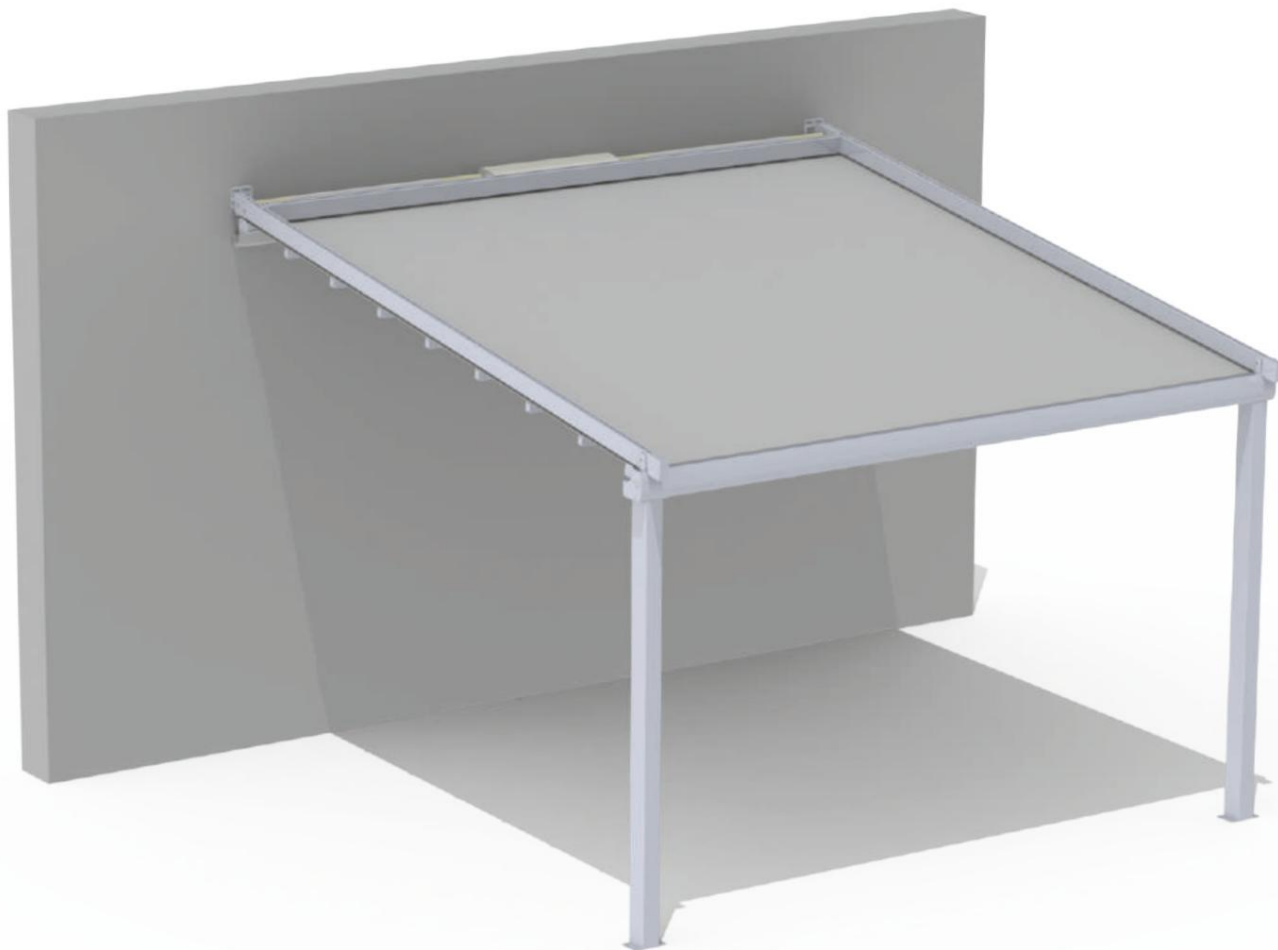

RACCORDI IN METALLO ZINCATO STANDARD
PARTI METALLICHE STANDARD ZINCATE

COLORI STANDARD



MOVIMENTO



LUCENTEZZA



ZABULINO DI ZIMIRELLA



TESSUTI TECNICI



ASSE / ASSE	SCARICA / PROIEZIONE					
	2.50	3.00	3.50	4.00	4.50	5.00
2.50	€ 2.812y	€ 2.915y	€ 2.986y	€ 3.090y	€ 3.193y	€ 3.329y
3.00	€ 2.909y	€ 3.021y	€ 3.096y	€ 3.208y	€ 3.320y	€ 3.467y
3.50	€ 3.036y	€ 3.158y	€ 3.237y	€ 3.358y	€ 3.479y	€ 3.637y
4.00	€ 3.133y	€ 3.263y	€ 3.347y	€ 3.477y	€ 3.607y	€ 3.775y
4.50	€ 3.260y	€ 3.399y	€ 3.487y	€ 3.626y	€ 3.765y	€ 3.943y
5.00	€ 3.741y	€ 3.917y	€ 4.034y	€ 4.210y	€ 4.387y	€ 4.610y
5.50	€ 3.837y	€ 4.023y	€ 4.144y	€ 4.329y	€ 4.515y	€ 4.748y
6.00	€ 3.934y	€ 4.128y	€ 4.254y	€ 4.448y	€ 4.642y	€ 4.886y
6.50	€ 4.070y	€ 4.273y	€ 4.403y	€ 4.607y	€ 4.850y	€ 5.055y
7.00	€ 4.175y	€ 4.388y	€ 4.522y	€ 4.764y	€ 4.979y	€ 5.193y
7.50	€ 4.306y	€ 4.533y	€ 4.681y	€ 4.928y	€ 5.157y	€ 5.385y
8.00	€ 4.403y	€ 4.639y	€ 4.801y	€ 5.048y	€ 5.286y	€ 5.605y
8.50	€ 4.531y	€ 4.804y	€ 4.953y	€ 5.199y	€ 5.446y	€ 5.774y
9.00	€ 4.665y	€ 4.921y	€ 5.074y	€ 5.330y	€ 5.586y	€ 5.924y
9.50	€ 5.193y	€ 5.487y	€ 5.670y	€ 5.964y	€ 6.341y	€ 6.636y
10.00	€ 5.301y	€ 5.605y	€ 5.793y	€ 6.097y	€ 6.484y	€ 6.788y
10.50	€ 5.410y	€ 5.724y	€ 5.916y	€ 6.313y	€ 6.627y	€ 6.941y
11.00	€ 5.520y	€ 5.843y	€ 6.040y	€ 6.447y	€ 6.770y	€ 7.094y
11.50	€ 5.629y	€ 5.963y	€ 6.164y	€ 6.581y	€ 6.914y	€ 7.247y
12.00	€ 5.740y	€ 6.083y	€ 6.373y	€ 6.716y	€ 7.059y	€ 7.402y
12.50	€ 5.882y	€ 6.235y	€ 6.529y	€ 6.882y	€ 7.235y	€ 7.588y
13.00	€ 5.992y	€ 6.355y	€ 6.655y	€ 7.018y	€ 7.381y	€ 7.744y
13.50	€ 6.531y	€ 6.933y	€ 7.263y	€ 7.665y	€ 8.068y	€ 8.470y
14.00	€ 6.643y	€ 7.140y	€ 7.391y	€ 7.803y	€ 8.215y	€ 8.627y
14.50	€ 6.792y	€ 7.303y	€ 7.559y	€ 7.986y	€ 8.414y	€ 8.841y
15.00	€ 6.903y	€ 7.424y	€ 7.685y	€ 8.123y	€ 8.560y	€ 8.998y

I PREZZI INCLUDONO IL MOTORE - DRIVE BOX (SAFETY BOX)

I PREZZI INCLUDONO IL MOTORE (SAFETY BOX)

I PREZZI NON INCLUDONO INSTALLAZIONE E IVA.

I PREZZI NON INCLUDONO INSTALLAZIONE E IVA

PER LA SCELTA DELL'ACCIAIO INOX, MAGGIORAZIONE DEL 5% SUL PREZZO DI LISTINO

PER PARTI INOX AGGIUNTA DEL 5% SUL PREZZO DI LISTINO

MOTORE MOTORE

■ 55/17, 85/17

BEAUFORT

°5 °6 °7 °8 °9 



VERNICE RAL 8% SUL

LISTINO PER SCELTA FUORI DAI
7 STANDARD

VERNICE RAL 8% SUL PREZZO DI LISTINO
PER LA SELEZIONE TRA 7 STANDARD

FLOPER 100 CON TIRANTE E TRAVE

FLOPER 100 CON GRONDAIA E TRAVE

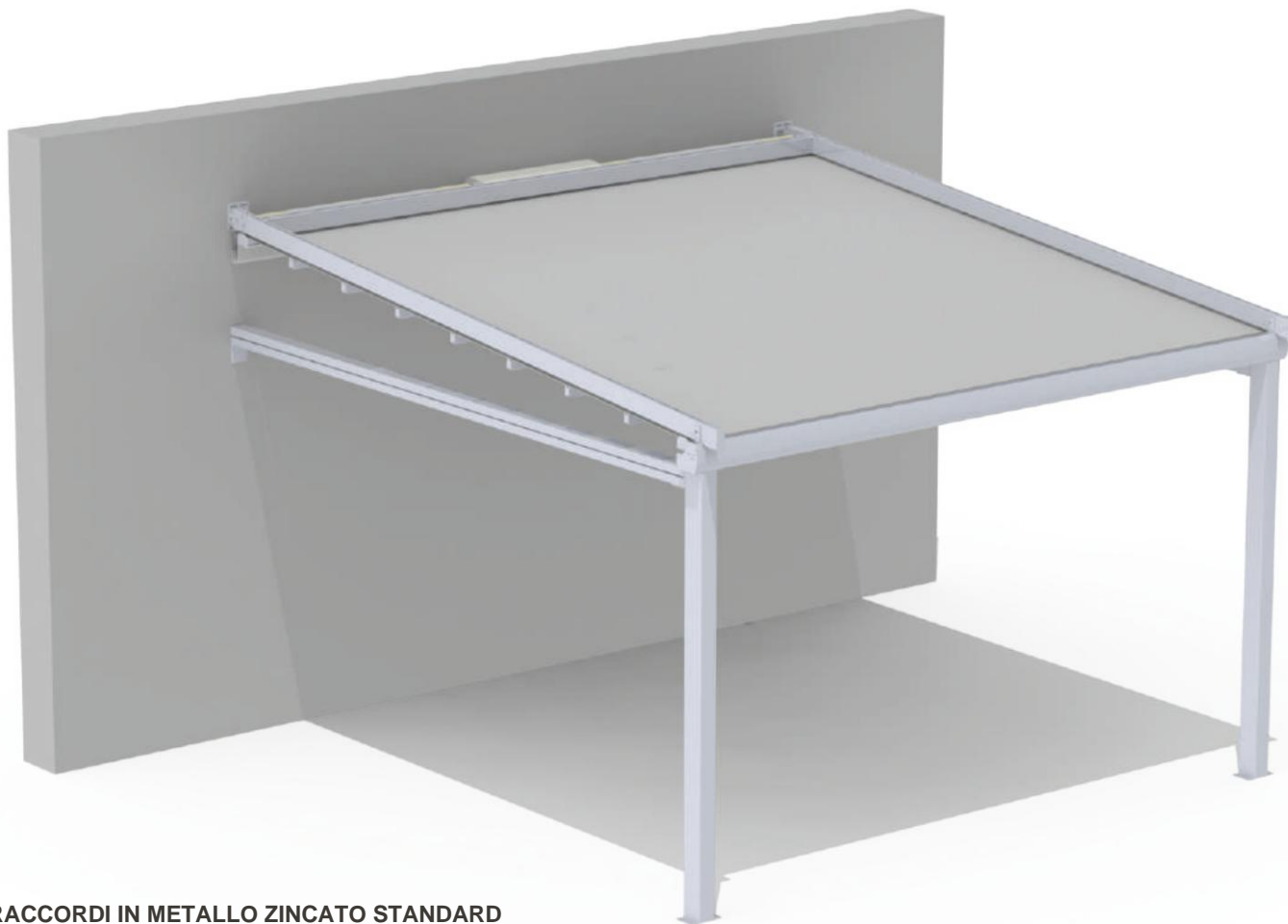

RACCORDI IN METALLO ZINCATO STANDARD
PARTI METALLICHE STANDARD ZINCATE

COLORI STANDARD



MOVIMENTO



LUCENTEZZA



ZABULINO DI ZIMIRELLA



TESSUTI TECNICI



ASSE / ASSE	SCARICA / PROIEZIONE					
	2.50	3.00	3.50	4.00	4.50	5.00
2.50	€ 3.134y	€ 3.277y	€ 3.388y	€ 3.531y	€ 3.675y	€ 3.857y
3.00	€ 3.230y	€ 3.383y	€ 3.498y	€ 3.650y	€ 3.803y	€ 3.995y
3.50	€ 3.358y	€ 3.519y	€ 3.639y	€ 3.800y	€ 3.961y	€ 4.164y
4.00	€ 3.455y	€ 3.625y	€ 3.749y	€ 3.919y	€ 4.089y	€ 4.302y
4.50	€ 3.582y	€ 3.761y	€ 3.889y	€ 4.068y	€ 4.247y	€ 4.471y
5.00	€ 4.062y	€ 4.279y	€ 4.436y	€ 4.652y	€ 4.869y	€ 5.137y
5.50	€ 4.159y	€ 4.384y	€ 4.546y	€ 4.771y	€ 4.997y	€ 5.275y
6.00	€ 4.255y	€ 4.490y	€ 4.655y	€ 4.890y	€ 5.124y	€ 5.413y
6.50	€ 4.392y	€ 4.636y	€ 4.806y	€ 5.050y	€ 5.336y	€ 5.582y
7.00	€ 4.498y	€ 4.751y	€ 4.926y	€ 5.211y	€ 5.465y	€ 5.720y
7.50	€ 4.629y	€ 4.896y	€ 5.085y	€ 5.375y	€ 5.644y	€ 5.913y
8.00	€ 4.726y	€ 5.002y	€ 5.206y	€ 5.495y	€ 5.773y	€ 6.133y
8.50	€ 4.854y	€ 5.170y	€ 5.359y	€ 5.645y	€ 5.932y	€ 6.302y
9.00	€ 4.990y	€ 5.287y	€ 5.480y	€ 5.777y	€ 6.074y	€ 6.452y
9.50	€ 5.519y	€ 5.854y	€ 6.077y	€ 6.412y	€ 6.830y	€ 7.165y
10.00	€ 5.628y	€ 5.973y	€ 6.201y	€ 6.546y	€ 6.973y	€ 7.318y
10.50	€ 5.738y	€ 6.092y	€ 6.325y	€ 6.763y	€ 7.118y	€ 7.472y
11.00	€ 5.848y	€ 6.212y	€ 6.450y	€ 6.897y	€ 7.262y	€ 7.626y
11.50	€ 5.958y	€ 6.332y	€ 6.575y	€ 7.033y	€ 7.407y	€ 7.781y
12.00	€ 6.069y	€ 6.453y	€ 6.784y	€ 7.168y	€ 7.553y	€ 7.937y
12.50	€ 6.212y	€ 6.606y	€ 6.941y	€ 7.336y	€ 7.730y	€ 8.124y
13.00	€ 6.323y	€ 6.727y	€ 7.068y	€ 7.472y	€ 7.876y	€ 8.280y
13.50	€ 6.862y	€ 7.306y	€ 7.677y	€ 8.121y	€ 8.564y	€ 9.008y
14.00	€ 6.975y	€ 7.513y	€ 7.806y	€ 8.259y	€ 8.713y	€ 9.167y
14.50	€ 7.124y	€ 7.677y	€ 7.975y	€ 8.444y	€ 8.912y	€ 9.381y
15.00	€ 7.236y	€ 7.799y	€ 8.102y	€ 8.581y	€ 9.060y	€ 9.539y

I PREZZI INCLUDONO IL MOTORE - DRIVE BOX (SAFETY BOX)

I PREZZI INCLUDONO IL MOTORE (SAFETY BOX)

I PREZZI NON INCLUDONO INSTALLAZIONE E IVA.

I PREZZI NON INCLUDONO INSTALLAZIONE E IVA

PER LA SCELTA DELL'ACCIAIO INOX, MAGGIORAZIONE DEL 6% SUL PREZZO DI LISTINO

PER PARTI INOX AGGIUNTA DEL 6% SUL PREZZO DI LISTINO

MOTORE MOTORE

■ 55/17, 85/17

BEAUFORT

*5 *6 *7 *8 *9



VERNICE RAL 8% SUL LISTINO PER SCELTA FUORI DAI 7 STANDARD

VERNICE RAL 8% SUL PREZZO DI LISTINO PER SELEZIONE TRA 7 STANDARD

FLOPPER 120

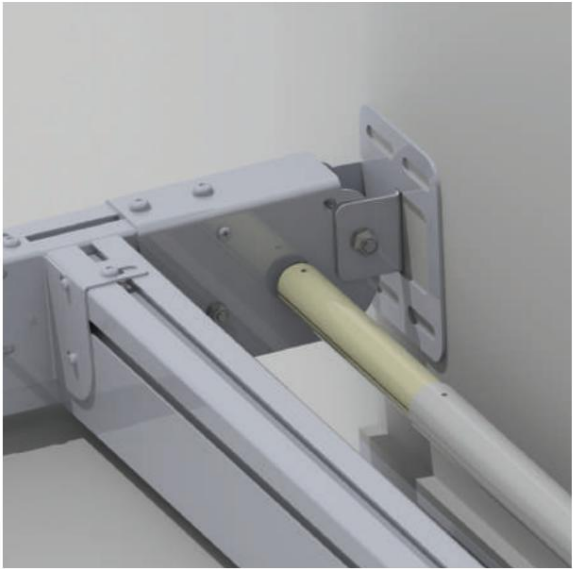
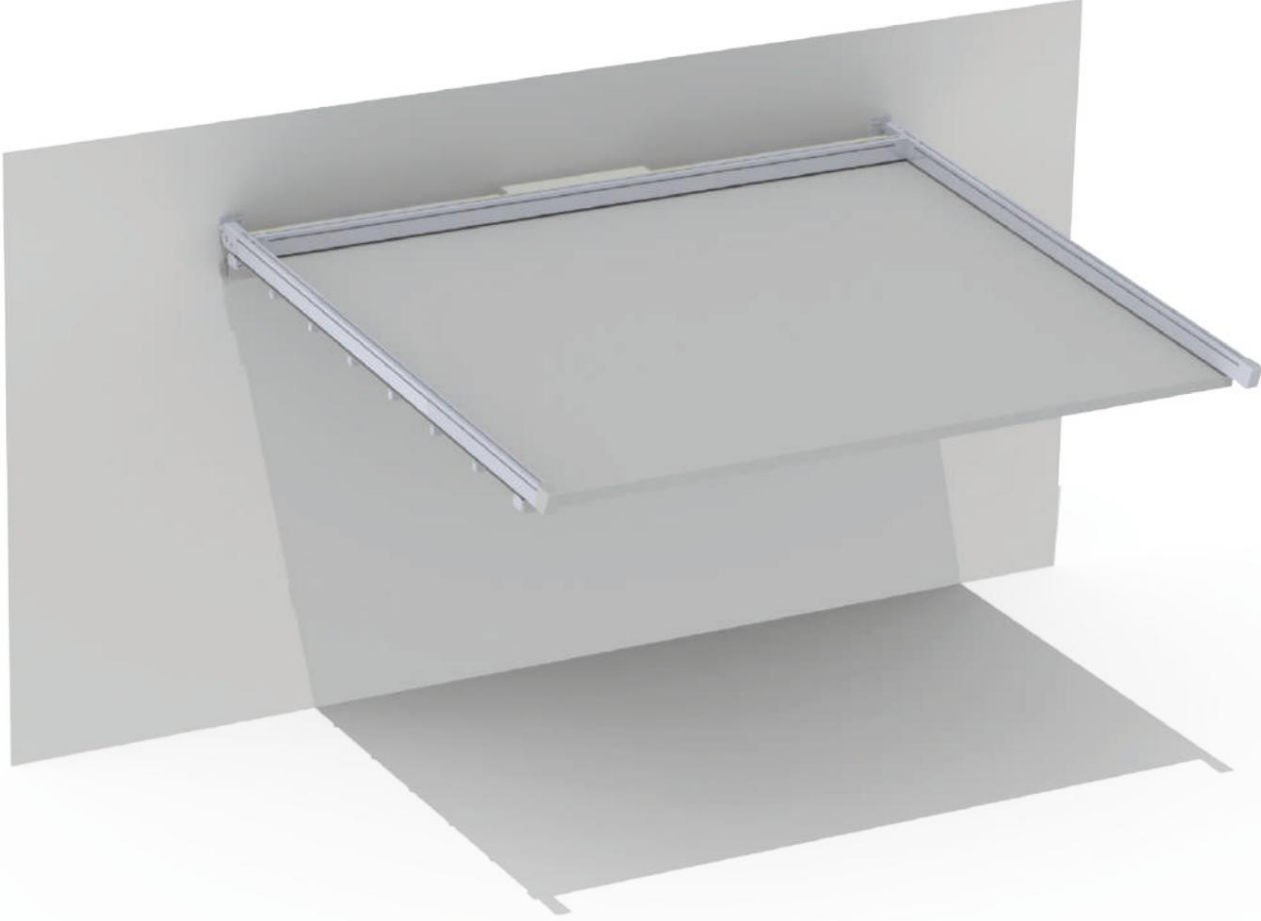

RACCORDI IN METALLO ZINCATO STANDARD
PARTI METALLICHE STANDARD ZINCATE

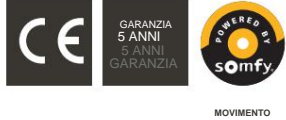

COLORI STANDARD

Colore RAL 1013	9010	7040	1019	9005	7021	8014
-----------------	------	------	------	------	------	------

LUCENTEZZA
ZABULINO DI ZIMIRELLA



TESSUTI TECNICI

ASSE / ASSE	SCARICA / PROIEZIONE							
	2.50	3.00	3.50	4.00	4.50	5.00	5.50	6.00
2.50	€ 2.340y	€ 2.456y	€ 2.538y	€ 2.653y	€ 2.769y	€ 2.913y	€ 3.029y	€ 3.146y
3.00	€ 2.408y	€ 2.533y	€ 2.619y	€ 2.743y	€ 2.868y	€ 3.022y	€ 3.148y	€ 3.273y
3.50	€ 2.518y	€ 2.652y	€ 2.742y	€ 2.876y	€ 3.009y	€ 3.174y	€ 3.309y	€ 3.444y
4.00	€ 2.586y	€ 2.728y	€ 2.823y	€ 2.966y	€ 3.108y	€ 3.284y	€ 3.427y	€ 3.571y
4.50	€ 2.695y	€ 2.847y	€ 2.946y	€ 3.098y	€ 3.249y	€ 3.435y	€ 3.588y	€ 3.741y
5.00	€ 2.977y	€ 3.172y	€ 3.306y	€ 3.501y	€ 3.696y	€ 3.930y	€ 4.127y	€ 4.406y
5.50	€ 3.045y	€ 3.249y	€ 3.387y	€ 3.591y	€ 3.795y	€ 4.039y	€ 4.245y	€ 4.534y
6.00	€ 3.113y	€ 3.326y	€ 3.468y	€ 3.681y	€ 3.894y	€ 4.149y	€ 4.364y	€ 4.662y
6.50	€ 3.229y	€ 3.452y	€ 3.599y	€ 3.821y	€ 4.076y	€ 4.301y	€ 4.525y	€ 4.832y
7.00	€ 3.304y	€ 3.536y	€ 3.688y	€ 3.943y	€ 4.177y	€ 4.410y	€ 4.726y	€ 4.959y
7.50	€ 3.406y	€ 3.652y	€ 3.816y	€ 4.079y	€ 4.326y	€ 4.574y	€ 4.904y	€ 5.152y
8.00	€ 3.474y	€ 3.729y	€ 3.905y	€ 4.170y	€ 4.427y	€ 4.766y	€ 5.023y	€ 5.279y
8.50	€ 3.584y	€ 3.871y	€ 4.037y	€ 4.303y	€ 4.569y	€ 4.917y	€ 5.183y	€ 5.449y
9.00	€ 3.681y	€ 3.957y	€ 4.127y	€ 4.403y	€ 4.678y	€ 5.037y	€ 5.312y	€ 5.588y
9.50	€ 4.017y	€ 4.337y	€ 4.543y	€ 4.863y	€ 5.266y	€ 5.586y	€ 5.906y	€ 6.226y
10.00	€ 4.094y	€ 4.424y	€ 4.635y	€ 4.965y	€ 5.378y	€ 5.708y	€ 6.037y	€ 6.367y
10.50	€ 4.171y	€ 4.511y	€ 4.727y	€ 5.150y	€ 5.490y	€ 5.829y	€ 6.169y	€ 6.509y
11.00	€ 4.249y	€ 4.598y	€ 4.819y	€ 5.252y	€ 5.602y	€ 5.951y	€ 6.301y	€ 6.651y
11.50	€ 4.326y	€ 4.686y	€ 4.911y	€ 5.355y	€ 5.714y	€ 6.074y	€ 6.433y	€ 6.793y
12.00	€ 4.405y	€ 4.774y	€ 5.088y	€ 5.458y	€ 5.827y	€ 6.197y	€ 6.566y	€ 6.936y
12.50	€ 4.526y	€ 4.905y	€ 5.224y	€ 5.604y	€ 5.983y	€ 6.363y	€ 6.743y	€ 7.122y
13.00	€ 4.604y	€ 4.994y	€ 5.318y	€ 5.708y	€ 6.097y	€ 6.487y	€ 6.876y	€ 7.266y
13.50	€ 4.947y	€ 5.382y	€ 5.743y	€ 6.178y	€ 6.613y	€ 7.048y	€ 7.483y	€ 7.918y
14.00	€ 5.026y	€ 5.556y	€ 5.837y	€ 6.283y	€ 6.728y	€ 7.173y	€ 7.618y	€ 8.064y
14.50	€ 5.142y	€ 5.687y	€ 5.973y	€ 6.434y	€ 6.894y	€ 7.355y	€ 7.816y	€ 8.276y
15.00	€ 5.220y	€ 5.775y	€ 6.067y	€ 6.537y	€ 7.008y	€ 7.479y	€ 7.950y	€ 8.421y

I PREZZI INCLUDONO IL MOTORE - DRIVE BOX (SAFETY BOX)

I PREZZI INCLUDONO IL MOTORE (SAFETY BOX)

I PREZZI NON INCLUDONO INSTALLAZIONE E IVA.

I PREZZI NON INCLUDONO INSTALLAZIONE E IVA

PER LA SCELTA DELL'ACCIAIO INOX, MAGGIORAZIONE DEL 4% SUL PREZZO DI LISTINO

PER PARTI INOX AGGIUNTA DEL 4% SUL PREZZO DI LISTINO

MOTORE MOTORE

■ 55/17, 85/17

BEAUFORT

*7 *8 *9 *10



VERNICE RAL 8% SUL
LISTINO PER SCELTA FUORI DAI
7 STANDARD

VERNICE RAL 8% SUL PREZZO DI LISTINO PER
SELEZIONE TRA 7 STANDARD

FLOPER 120 CON SENO

FLOPER 120 CON GRONDAIA

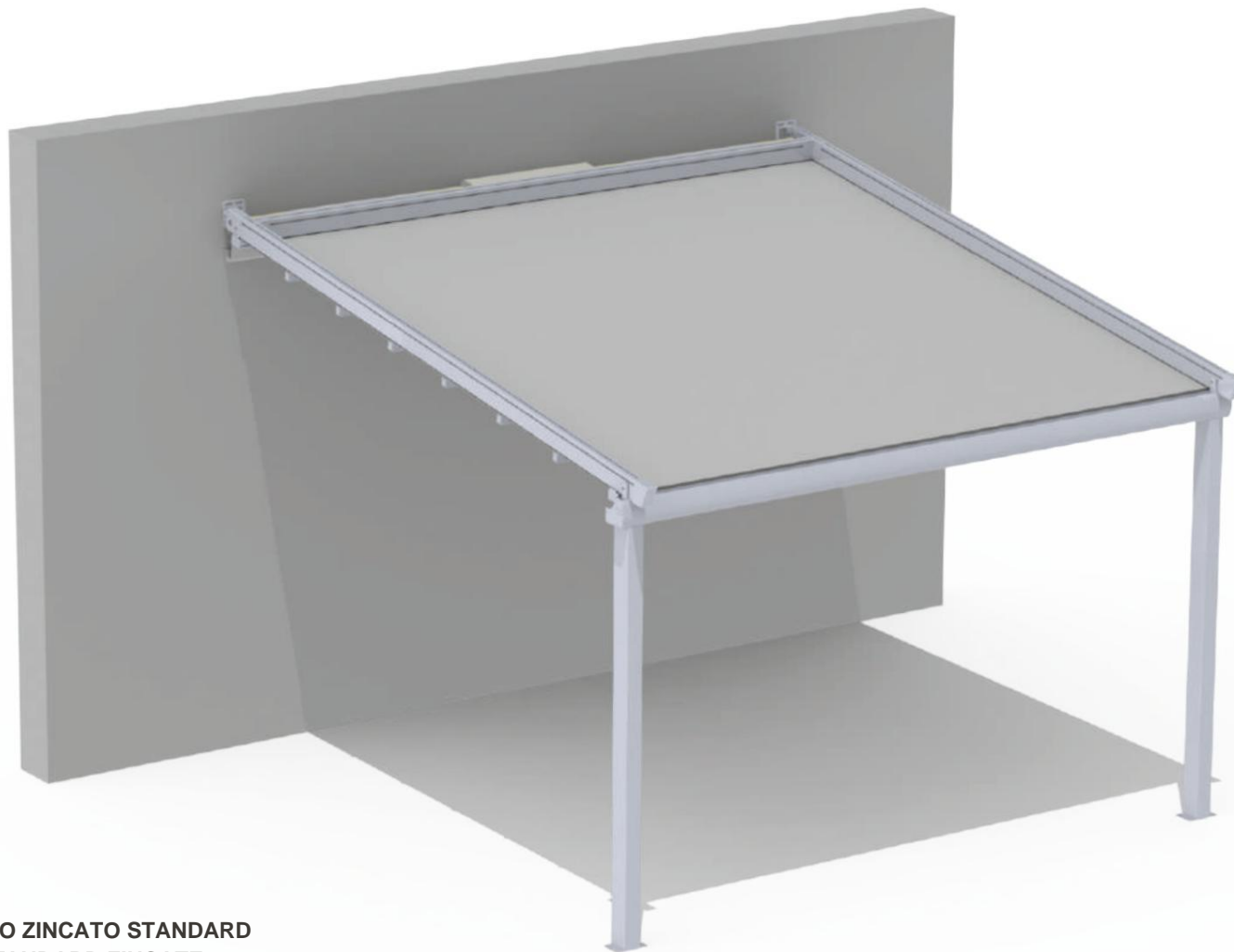

RACCORDI IN METALLO ZINCATO STANDARD
PARTI METALLICHE STANDARD ZINCATE



MOVIMENTO

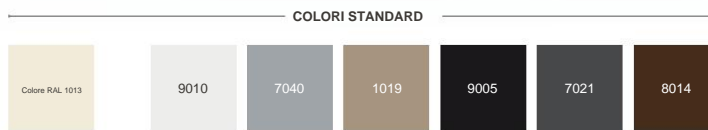

LUCENTEZZA

ZABULINO DI ZIMIRELLA



TESSUTI TECNICI



ASSE / ASSE	SCARICA / PROIEZIONE							
	2.50	3.00	3.50	4.00	4.50	5.00	5.50	6.00
2.50	€ 2.964y	€ 3.080y	€ 3.163y	€ 3.279y	€ 3.395y	€ 3.547y	€ 3.664y	€ 3.781y
3.00	€ 3.063y	€ 3.188y	€ 3.275y	€ 3.401y	€ 3.526y	€ 3.688y	€ 3.814y	€ 3.941y
3.50	€ 3.204y	€ 3.339y	€ 3.430y	€ 3.565y	€ 3.699y	€ 3.872y	€ 4.008y	€ 4.143y
4.00	€ 3.303y	€ 3.447y	€ 3.543y	€ 3.686y	€ 3.829y	€ 4.013y	€ 4.158y	€ 4.303y
4.50	€ 3.444y	€ 3.597y	€ 3.697y	€ 3.849y	€ 4.002y	€ 4.197y	€ 4.351y	€ 4.505y
5.00	€ 3.947y	€ 4.143y	€ 4.279y	€ 4.475y	€ 4.671y	€ 4.916y	€ 5.115y	€ 5.396y
5.50	€ 4.046y	€ 4.251y	€ 4.391y	€ 4.596y	€ 4.802y	€ 5.057y	€ 5.265y	€ 5.556y
6.00	€ 4.145y	€ 4.359y	€ 4.503y	€ 4.718y	€ 4.932y	€ 5.199y	€ 5.415y	€ 5.715y
6.50	€ 4.295y	€ 4.519y	€ 4.667y	€ 4.891y	€ 5.157y	€ 5.383y	€ 5.608y	€ 5.918y
7.00	€ 4.403y	€ 4.637y	€ 4.790y	€ 5.054y	€ 5.289y	€ 5.524y	€ 5.842y	€ 6.077y
7.50	€ 4.546y	€ 4.785y	€ 4.952y	€ 5.221y	€ 5.471y	€ 5.720y	€ 6.052y	€ 6.302y
8.00	€ 4.655y	€ 4.893y	€ 5.075y	€ 5.344y	€ 5.602y	€ 5.944y	€ 6.203y	€ 6.461y
8.50	€ 4.807y	€ 5.074y	€ 5.241y	€ 5.509y	€ 5.777y	€ 6.128y	€ 6.395y	€ 6.663y
9.00	€ 4.916y	€ 5.194y	€ 5.366y	€ 5.643y	€ 5.920y	€ 6.281y	€ 6.559y	€ 6.836y
9.50	€ 5.479y	€ 5.801y	€ 6.009y	€ 6.331y	€ 6.737y	€ 7.059y	€ 7.382y	€ 7.704y
10.00	€ 5.590y	€ 5.923y	€ 6.135y	€ 6.467y	€ 6.883y	€ 7.216y	€ 7.548y	€ 7.880y
10.50	€ 5.703y	€ 6.045y	€ 6.262y	€ 6.688y	€ 7.030y	€ 7.372y	€ 7.714y	€ 8.057y
11.00	€ 5.815y	€ 6.167y	€ 6.389y	€ 6.825y	€ 7.177y	€ 7.529y	€ 7.882y	€ 8.234y
11.50	€ 5.927y	€ 6.289y	€ 6.516y	€ 6.963y	€ 7.325y	€ 7.687y	€ 8.049y	€ 8.411y
12.00	€ 6.041y	€ 6.413y	€ 6.729y	€ 7.101y	€ 7.474y	€ 7.846y	€ 8.218y	€ 8.590y
12.50	€ 6.197y	€ 6.579y	€ 6.901y	€ 7.283y	€ 7.665y	€ 8.048y	€ 8.430y	€ 8.812y
13.00	€ 6.311y	€ 6.703y	€ 7.030y	€ 7.422y	€ 7.815y	€ 8.207y	€ 8.600y	€ 8.992y
13.50	€ 6.885y	€ 7.323y	€ 7.687y	€ 8.125y	€ 8.563y	€ 9.001y	€ 9.439y	€ 9.877y
14.00	€ 7.001y	€ 7.534y	€ 7.818y	€ 8.266y	€ 8.714y	€ 9.163y	€ 9.611y	€ 10.060y
14.50	€ 7.153y	€ 7.702y	€ 7.990y	€ 8.454y	€ 8.918y	€ 9.382y	€ 9.845y	€ 10.309y
15.00	€ 7.267y	€ 7.826y	€ 8.120y	€ 8.594y	€ 9.068y	€ 9.542y	€ 10.016y	€ 10.491y

I PREZZI INCLUDONO IL MOTORE - DRIVE BOX (SAFETY BOX)

I PREZZI INCLUDONO IL MOTORE (SAFETY BOX)

I PREZZI NON INCLUDONO INSTALLAZIONE E IVA.

I PREZZI NON INCLUDONO INSTALLAZIONE E IVA

PER LA SCELTA DELL'ACCIAIO INOX, MAGGIORAZIONE DEL 5% SUL PREZZO DI LISTINO

PER PARTI INOX AGGIUNTA DEL 5% SUL PREZZO DI LISTINO

MOTORE MOTORE

■ 55/17, 85/17

BEAUFORT

*7 *8 *9 *10



VERNICE RAL 8% SUL
LISTINO PER SCELTA FUORI DAI
7 STANDARD

VERNICE RAL 8% SUL PREZZO DI LISTINO PER
SELEZIONE TRA 7 STANDARD

FLOPER 120 CON RINFORZO E TRAVE

FLOPER 120 CON GRONDAIA E SUPPORTO TRAVE LATERALE

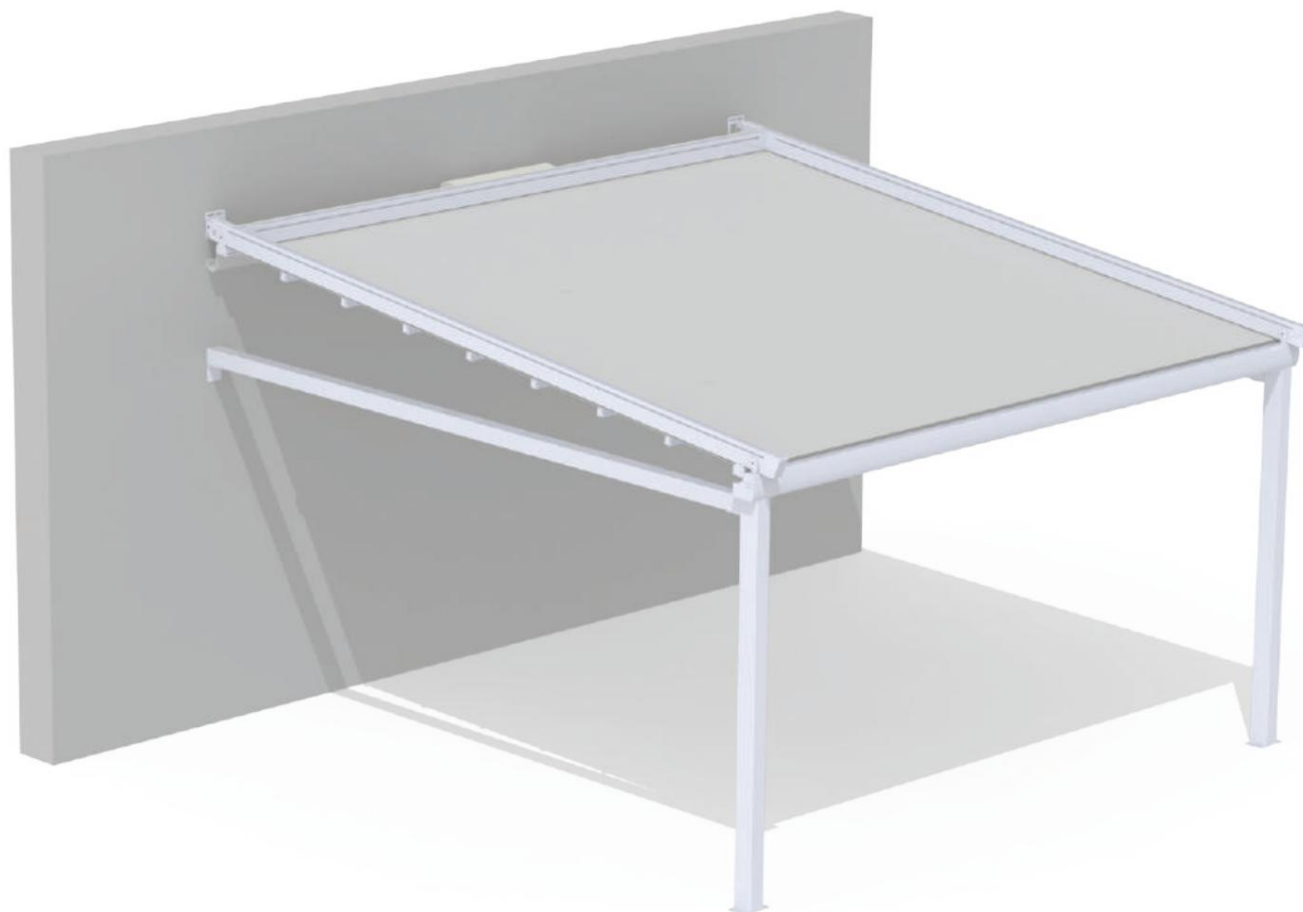

PER UN PIAZZOLINO SUPERIORE A 5 M, VENGONO INSTALLATE LATERALMENTE UNA TRAVE E UNA COLONNA 100X100.
PER SPORGENZE SUPERIORI A 5 M, VIENE POSIZIONATA UNA COLONNA SULLA TRAVE LATERALE 100X100.

RACCORDI IN METALLO ZINCATO STANDARD
PARTI METALLICHE STANDARD ZINCATE



MOVIMENTO

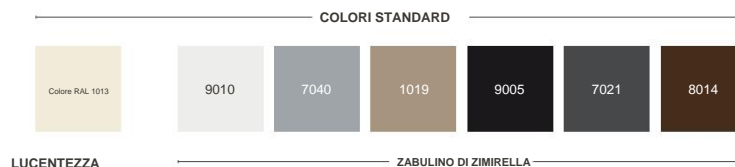

TESSUTI TECNICI



ASSE / ASSE	SCARICA / PROIEZIONE							
	2.50	3.00	3.50	4.00	4.50	5.00	5.50	6.00
2.50	€ 3.290y	€ 3.447y	€ 3.571y	€ 3.727y	€ 3.884y	€ 4.082y	€ 4.503y	€ 4.662y
3.00	€ 3.389y	€ 3.555y	€ 3.683y	€ 3.849y	€ 4.015y	€ 4.223y	€ 4.654y	€ 4.821y
3.50	€ 3.531y	€ 3.706y	€ 3.838y	€ 4.013y	€ 4.188y	€ 4.407y	€ 4.847y	€ 5.024y
4.00	€ 3.629y	€ 3.814y	€ 3.950y	€ 4.134y	€ 4.318y	€ 4.548y	€ 4.997y	€ 5.183y
4.50	€ 3.770y	€ 3.964y	€ 4.104y	€ 4.298y	€ 4.491y	€ 4.732y	€ 5.190y	€ 5.385y
5.00	€ 4.273y	€ 4.510y	€ 4.686y	€ 4.923y	€ 5.160y	€ 5.451y	€ 5.954y	€ 6.276y
5.50	€ 4.372y	€ 4.618y	€ 4.798y	€ 5.044y	€ 5.290y	€ 5.592y	€ 6.104y	€ 6.436y
6.00	€ 4.471y	€ 4.726y	€ 4.911y	€ 5.166y	€ 5.421y	€ 5.734y	€ 6.254y	€ 6.595y
6.50	€ 4.622y	€ 4.887y	€ 5.076y	€ 5.341y	€ 5.651y	€ 5.918y	€ 6.448y	€ 6.798y
7.00	€ 4.730y	€ 5.005y	€ 5.199y	€ 5.506y	€ 5.783y	€ 6.059y	€ 6.681y	€ 6.957y
7.50	€ 4.864y	€ 5.153y	€ 5.362y	€ 5.674y	€ 5.964y	€ 6.255y	€ 6.892y	€ 7.182y
8.00	€ 4.964y	€ 5.261y	€ 5.486y	€ 5.797y	€ 6.096y	€ 6.479y	€ 7.042y	€ 7.342y
8.50	€ 5.105y	€ 5.445y	€ 5.653y	€ 5.962y	€ 6.271y	€ 6.663y	€ 7.235y	€ 7.543y
9.00	€ 5.246y	€ 5.565y	€ 5.778y	€ 6.097y	€ 6.415y	€ 6.817y	€ 7.400y	€ 7.718y
9.50	€ 5.810y	€ 6.173y	€ 6.422y	€ 6.786y	€ 7.233y	€ 7.597y	€ 8.224y	€ 8.588y
10.00	€ 5.922y	€ 6.295y	€ 6.549y	€ 6.923y	€ 7.380y	€ 7.754y	€ 8.392y	€ 8.765y
10.50	€ 6.035y	€ 6.418y	€ 6.677y	€ 7.144y	€ 7.528y	€ 7.912y	€ 8.560y	€ 8.944y
11.00	€ 6.147y	€ 6.541y	€ 6.805y	€ 7.283y	€ 7.676y	€ 8.070y	€ 8.729y	€ 9.123y
11.50	€ 6.261y	€ 6.664y	€ 6.933y	€ 7.421y	€ 7.825y	€ 8.229y	€ 8.899y	€ 9.302y
12.00	€ 6.375y	€ 6.789y	€ 7.147y	€ 7.560y	€ 7.974y	€ 8.388y	€ 9.069y	€ 9.483y
12.50	€ 6.532y	€ 6.956y	€ 7.319y	€ 7.743y	€ 8.167y	€ 8.591y	€ 9.283y	€ 9.707y
13.00	€ 6.646y	€ 7.081y	€ 7.449y	€ 7.883y	€ 8.318y	€ 8.752y	€ 9.454y	€ 9.888y
13.50	€ 7.221y	€ 7.701y	€ 8.106y	€ 8.587y	€ 9.067y	€ 9.547y	€ 10.295y	€ 10.775y
14.00	€ 7.338y	€ 7.913y	€ 8.238y	€ 8.729y	€ 9.219y	€ 9.710y	€ 10.469y	€ 10.959y
14.50	€ 7.490y	€ 8.081y	€ 8.412y	€ 8.917y	€ 9.423y	€ 9.929y	€ 10.705y	€ 11.211y
15.00	€ 7.605y	€ 8.207y	€ 8.542y	€ 9.058y	€ 9.575y	€ 10.091y	€ 10.877y	€ 11.394y

I PREZZI INCLUDONO IL MOTORE - DRIVE BOX (SAFETY BOX)

I PREZZI INCLUDONO IL MOTORE (SAFETY BOX)

I PREZZI NON INCLUDONO INSTALLAZIONE E IVA.

I PREZZI NON INCLUDONO INSTALLAZIONE E IVA

PER LA SCELTA DELL'ACCIAIO INOX, MAGGIORAZIONE DEL 6% SUL PREZZO DI LISTINO

PER PARTI INOX AGGIUNTA DEL 6% SUL PREZZO DI LISTINO

MOTORE MOTORE

■ 55/17, 85/17

BEAUFORT

*7 *8 *9 *10



VERNICE RAL 8% SUL
LISTINO PER SCELTA FUORI DAI
7 STANDARD

VERNICE RAL 8% SUL PREZZO DI LISTINO PER
SELEZIONE TRA 7 STANDARD

FLOPPER 140

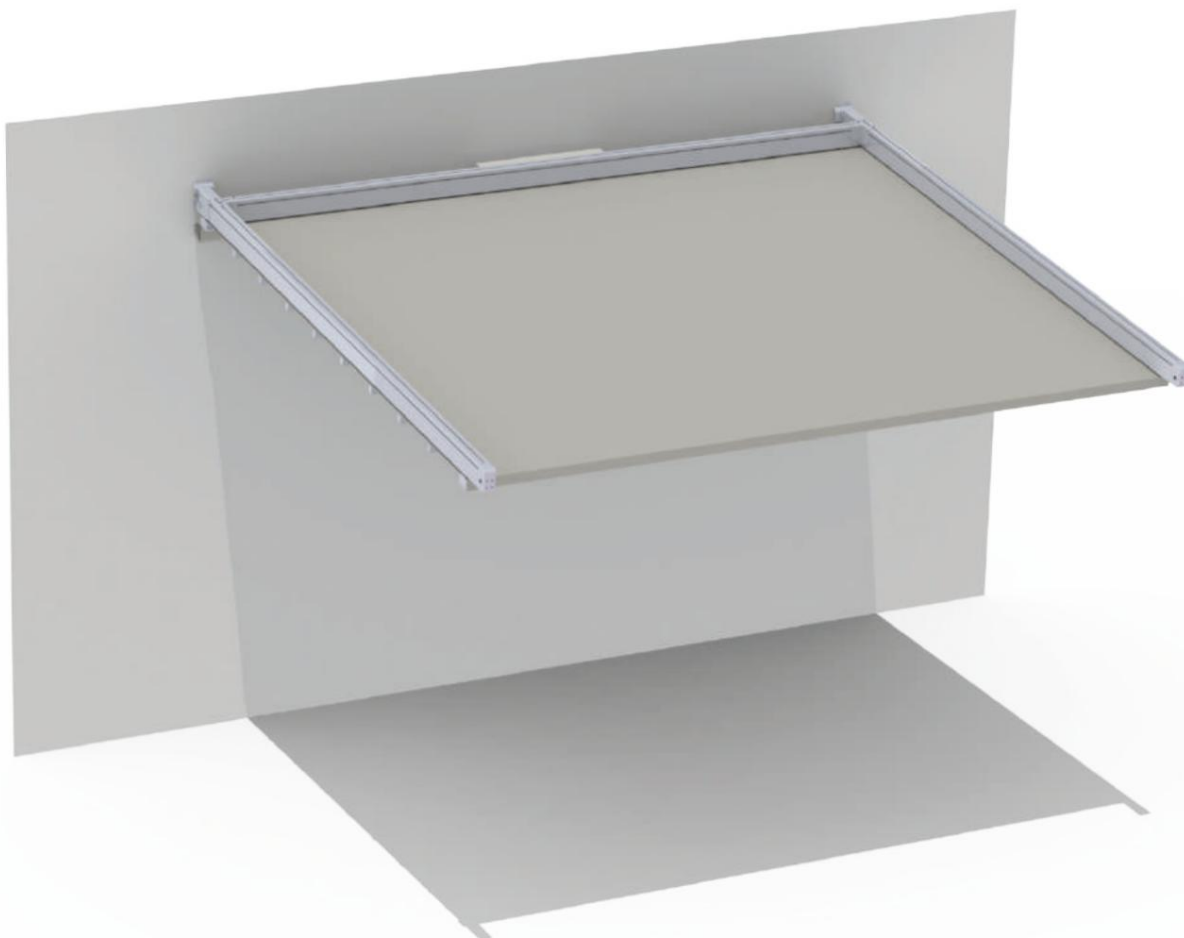

SUPPORTO
A PARETE
PARETE
MONTATO

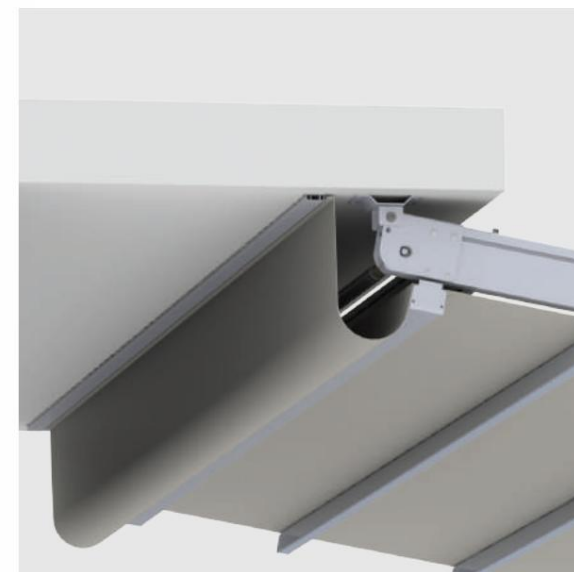

SUPPORTO
SULLA TENDA
SOFFITTO
MONTATO

RACCORDI IN METALLO ZINCATO STANDARD
PARTI METALLICHE STANDARD ZINCATE



MOVIMENTO

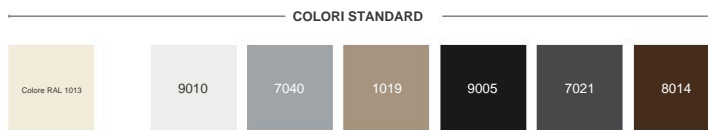

LUCENTEZZA

ZABULINO DI ZIMIRELLA



TESSUTI TECNICI



ASSALE / ASSE	SCARICA / PROIEZIONE										
	2.50	3.00	3.50	4.00	4.50	5.00	5.50	6.00	6.50	7.00	7.50
2.50	€ 2.573y	€ 2.702y	€ 2.798y	€ 2.928y	€ 3.057y	€ 3.187y	€ 3.317y	€ 3.446y	€ 3.659y	€ 3.827y	€ 3.908y
3.00	€ 2.642y	€ 2.780y	€ 2.881y	€ 3.020y	€ 3.159y	€ 3.297y	€ 3.436y	€ 3.575y	€ 3.797y	€ 3.976y	€ 4.069y
3.50	€ 2.766y	€ 2.914y	€ 3.019y	€ 3.167y	€ 3.315y	€ 3.463y	€ 3.611y	€ 3.759y	€ 3.990y	€ 4.180y	€ 4.286y
4.00	€ 2.835y	€ 2.992y	€ 3.101y	€ 3.258y	€ 3.416y	€ 3.573y	€ 3.730y	€ 3.888y	€ 4.128y	€ 4.329y	€ 4.448y
4.50	€ 2.958y	€ 3.125y	€ 3.238y	€ 3.405y	€ 3.571y	€ 3.738y	€ 3.904y	€ 4.071y	€ 4.321y	€ 4.532y	€ 4.665y
5.00	€ 3.289y	€ 3.506y	€ 3.661y	€ 3.877y	€ 4.094y	€ 4.311y	€ 4.528y	€ 4.828y	€ 5.045y	€ 5.314y	€ 5.449y
5.50	€ 3.358y	€ 3.584y	€ 3.743y	€ 3.969y	€ 4.195y	€ 4.421y	€ 4.647y	€ 4.957y	€ 5.183y	€ 5.463y	€ 5.611y
6.00	€ 3.427y	€ 3.662y	€ 3.826y	€ 4.061y	€ 4.296y	€ 4.531y	€ 4.767y	€ 5.085y	€ 5.321y	€ 5.611y	€ 5.772y
6.50	€ 3.551y	€ 3.796y	€ 3.964y	€ 4.208y	€ 4.452y	€ 4.697y	€ 4.941y	€ 5.269y	€ 5.514y	€ 5.816y	€ 5.989y
7.00	€ 3.620y	€ 3.874y	€ 4.046y	€ 4.300y	€ 4.554y	€ 4.807y	€ 5.144y	€ 5.398y	€ 5.652y	€ 5.964y	€ 6.151y
7.50	€ 3.724y	€ 3.992y	€ 4.169y	€ 4.437y	€ 4.705y	€ 4.972y	€ 5.324y	€ 5.592y	€ 5.860y	€ 6.189y	€ 6.394y
8.00	€ 3.793y	€ 4.070y	€ 4.251y	€ 4.529y	€ 4.806y	€ 5.166y	€ 5.443y	€ 5.720y	€ 5.998y	€ 6.337y	€ 6.555y
8.50	€ 3.917y	€ 4.203y	€ 4.389y	€ 4.675y	€ 4.961y	€ 5.331y	€ 5.618y	€ 5.904y	€ 6.190y	€ 6.541y	€ 6.773y
9.00	€ 3.986y	€ 4.281y	€ 4.471y	€ 4.767y	€ 5.062y	€ 5.441y	€ 5.737y	€ 6.033y	€ 6.328y	€ 6.690y	€ 6.934y
9.50	€ 4.371y	€ 4.717y	€ 4.948y	€ 5.294y	€ 5.723y	€ 6.069y	€ 6.415y	€ 6.761y	€ 7.107y	€ 7.527y	€ 7.775y
10.00	€ 4.440y	€ 4.795y	€ 5.031y	€ 5.386y	€ 5.824y	€ 6.180y	€ 6.535y	€ 6.890y	€ 7.245y	€ 7.676y	€ 7.936y
10.50	€ 4.509y	€ 4.874y	€ 5.114y	€ 5.562y	€ 5.926y	€ 6.290y	€ 6.654y	€ 7.019y	€ 7.383y	€ 7.824y	€ 8.097y
11.00	€ 4.578y	€ 4.952y	€ 5.196y	€ 5.653y	€ 6.027y	€ 6.400y	€ 6.774y	€ 7.147y	€ 7.521y	€ 7.973y	€ 8.258y
11.50	€ 4.647y	€ 5.030y	€ 5.279y	€ 5.745y	€ 6.128y	€ 6.511y	€ 6.893y	€ 7.276y	€ 7.659y	€ 8.122y	€ 8.419y
12.00	€ 4.717y	€ 5.109y	€ 5.445y	€ 5.837y	€ 6.229y	€ 6.621y	€ 7.013y	€ 7.405y	€ 7.797y	€ 8.271y	€ 8.581y
12.50	€ 4.840y	€ 5.241y	€ 5.583y	€ 5.984y	€ 6.385y	€ 6.786y	€ 7.187y	€ 7.588y	€ 7.989y	€ 8.474y	€ 8.798y
13.00	€ 4.909y	€ 5.320y	€ 5.665y	€ 6.076y	€ 6.486y	€ 6.896y	€ 7.307y	€ 7.717y	€ 8.127y	€ 8.623y	€ 8.959y
13.50	€ 5.401y	€ 5.870y	€ 6.265y	€ 6.735y	€ 7.205y	€ 7.675y	€ 8.144y	€ 8.614y	€ 9.084y	€ 9.554y	€ 9.800y
14.00	€ 5.471y	€ 6.035y	€ 6.349y	€ 6.829y	€ 7.308y	€ 7.787y	€ 8.266y	€ 8.746y	€ 9.225y	€ 9.704y	€ 9.961y
14.50	€ 5.632y	€ 6.216y	€ 6.538y	€ 7.036y	€ 7.535y	€ 8.034y	€ 8.532y	€ 9.031y	€ 9.530y	€ 10.028y	€ 10.205y
15.00	€ 5.703y	€ 6.297y	€ 6.623y	€ 7.132y	€ 7.640y	€ 8.148y	€ 8.656y	€ 9.164y	€ 9.672y	€ 10.180y	€ 10.367y

I PREZZI INCLUDONO IL MOTORE - DRIVE BOX (SAFETY BOX)

I PREZZI INCLUDONO IL MOTORE (SAFETY BOX)

I PREZZI NON INCLUDONO INSTALLAZIONE E IVA.

I PREZZI NON INCLUDONO INSTALLAZIONE E IVA

PER LA SCELTA DELL'ACCIAIO INOX, MAGGIORAZIONE DEL 4% SUL PREZZO DI LISTINO

PER PARTI INOX AGGIUNTA DEL 4% SUL PREZZO DI LISTINO

MOTORE MOTORE

■ 55/17, 85/17

BEAUFORT

*6 °78 °9 °10 



VERNICE RAL 8% SUL LISTINO PER SCELTA FUORI DAI 7 STANDARD

VERNICE RAL 8% SUL PREZZO DI LISTINO PER SELEZIONE TRA 7 STANDARD

FLOPER 140 CON SENO

FLOPER 140 CON GRONDAIA

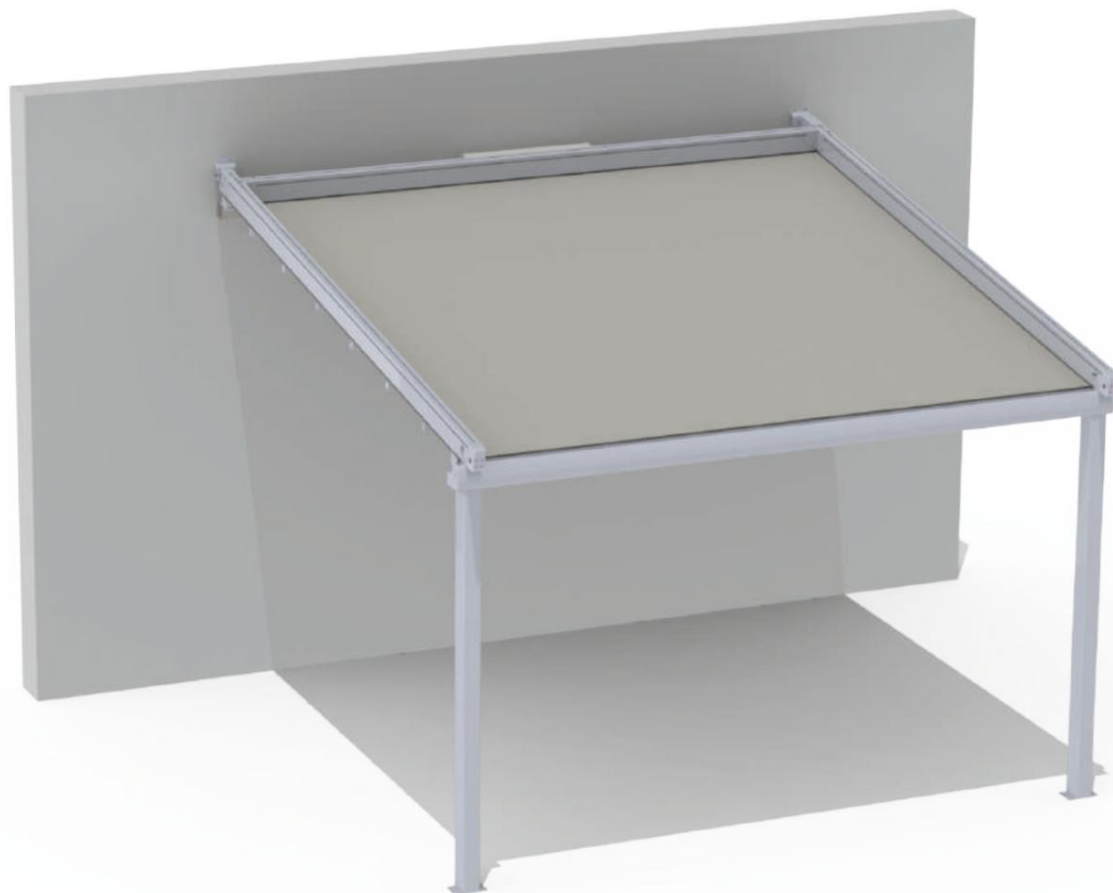

RACCORDI IN METALLO ZINCATO STANDARD
PARTI METALLICHE STANDARD ZINCATE

COLORI STANDARD



MOVIMENTO



LUCENTEZZA



ZABULINO DI ZIMIRELLA



TESSUTI TECNICI



ASSALE / ASSE	SCARICA / PROIEZIONE										
	2.50	3.00	3.50	4.00	4.50	5.00	5.50	6.00	6.50	7.00	7.50
2.50	€ 3.189y	€ 3.319y	€ 3.416y	€ 3.546y	€ 3.676y	€ 3.807y	€ 3.937y	€ 4.067y	€ 4.282y	€ 4.500y	€ 4.523y
3.00	€ 3.289y	€ 3.429y	€ 3.530y	€ 3.670y	€ 3.809y	€ 3.949y	€ 4.088y	€ 4.228y	€ 4.452y	€ 4.683y	€ 4.718y
3.50	€ 3.445y	€ 3.594y	€ 3.700y	€ 3.849y	€ 3.998y	€ 4.146y	€ 4.295y	€ 4.444y	€ 4.677y	€ 4.923y	€ 4.960y
4.00	€ 3.546y	€ 3.704y	€ 3.814y	€ 3.972y	€ 4.130y	€ 4.289y	€ 4.447y	€ 4.605y	€ 4.847y	€ 5.105y	€ 5.154y
4.50	€ 3.702y	€ 3.869y	€ 3.983y	€ 4.151y	€ 4.318y	€ 4.486y	€ 4.653y	€ 4.821y	€ 5.072y	€ 5.344y	€ 5.397y
5.00	€ 4.249y	€ 4.467y	€ 4.623y	€ 4.841y	€ 5.059y	€ 5.277y	€ 5.495y	€ 5.797y	€ 6.015y	€ 6.357y	€ 6.424y
5.50	€ 4.349y	€ 4.577y	€ 4.737y	€ 4.964y	€ 5.192y	€ 5.419y	€ 5.646y	€ 5.957y	€ 6.185y	€ 6.540y	€ 6.618y
6.00	€ 4.450y	€ 4.687y	€ 4.851y	€ 5.088y	€ 5.324y	€ 5.561y	€ 5.798y	€ 6.118y	€ 6.355y	€ 6.723y	€ 6.812y
6.50	€ 4.606y	€ 4.852y	€ 5.021y	€ 5.267y	€ 5.513y	€ 5.759y	€ 6.004y	€ 6.334y	€ 6.580y	€ 6.962y	€ 7.055y
7.00	€ 4.707y	€ 4.962y	€ 5.135y	€ 5.390y	€ 5.646y	€ 5.901y	€ 6.240y	€ 6.495y	€ 6.750y	€ 7.145y	€ 7.249y
7.50	€ 4.843y	€ 5.112y	€ 5.290y	€ 5.559y	€ 5.829y	€ 6.098y	€ 6.452y	€ 6.721y	€ 6.990y	€ 7.405y	€ 7.527y
8.00	€ 4.943y	€ 5.222y	€ 5.404y	€ 5.683y	€ 5.962y	€ 6.324y	€ 6.603y	€ 6.882y	€ 7.160y	€ 7.588y	€ 7.721y
8.50	€ 5.099y	€ 5.387y	€ 5.573y	€ 5.861y	€ 6.149y	€ 6.521y	€ 6.809y	€ 7.097y	€ 7.385y	€ 7.827y	€ 7.963y
9.00	€ 5.199y	€ 5.497y	€ 5.688y	€ 5.985y	€ 6.282y	€ 6.664y	€ 6.961y	€ 7.258y	€ 7.555y	€ 8.010y	€ 8.157y
9.50	€ 5.802y	€ 6.150y	€ 6.382y	€ 6.730y	€ 7.162y	€ 7.510y	€ 7.858y	€ 8.205y	€ 8.553y	€ 9.079y	€ 9.233y
10.00	€ 5.902y	€ 6.259y	€ 6.497y	€ 6.854y	€ 7.295y	€ 7.652y	€ 8.009y	€ 8.366y	€ 8.723y	€ 9.262y	€ 9.427y
10.50	€ 6.003y	€ 6.370y	€ 6.611y	€ 7.062y	€ 7.428y	€ 7.794y	€ 8.161y	€ 8.527y	€ 8.893y	€ 9.445y	€ 9.621y
11.00	€ 6.104y	€ 6.480y	€ 6.726y	€ 7.185y	€ 7.561y	€ 7.936y	€ 8.312y	€ 8.688y	€ 9.063y	€ 9.628y	€ 9.816y
11.50	€ 6.205y	€ 6.589y	€ 6.840y	€ 7.309y	€ 7.694y	€ 8.079y	€ 8.463y	€ 8.848y	€ 9.233y	€ 9.810y	€ 10.010y
12.00	€ 6.305y	€ 6.700y	€ 7.038y	€ 7.433y	€ 7.827y	€ 8.221y	€ 8.615y	€ 9.009y	€ 9.403y	€ 9.993y	€ 10.204y
12.50	€ 6.461y	€ 6.864y	€ 7.208y	€ 7.611y	€ 8.015y	€ 8.418y	€ 8.821y	€ 9.225y	€ 9.628y	€ 10.232y	€ 10.446y
13.00	€ 6.562y	€ 6.974y	€ 7.322y	€ 7.735y	€ 8.147y	€ 8.560y	€ 8.973y	€ 9.386y	€ 9.798y	€ 10.415y	€ 10.640y
13.50	€ 7.307y	€ 7.780y	€ 8.177y	€ 8.649y	€ 9.122y	€ 9.594y	€ 10.067y	€ 10.539y	€ 11.012y	€ 11.485y	€ 11.716y
14.00	€ 7.410y	€ 7.978y	€ 8.293y	€ 8.775y	€ 9.257y	€ 9.739y	€ 10.221y	€ 10.703y	€ 11.185y	€ 11.667y	€ 11.910y
14.50	€ 7.622y	€ 8.210y	€ 8.534y	€ 9.035y	€ 9.537y	€ 10.038y	€ 10.540y	€ 11.041y	€ 11.543y	€ 12.044y	€ 12.188y
15.00	€ 7.724y	€ 8.321y	€ 8.649y	€ 9.160y	€ 9.671y	€ 10.182y	€ 10.693y	€ 11.204y	€ 11.715y	€ 12.226y	€ 12.379y

I PREZZI INCLUDONO IL MOTORE - DRIVE BOX (SAFETY BOX)

I PREZZI INCLUDONO IL MOTORE (SAFETY BOX)

I PREZZI NON INCLUDONO INSTALLAZIONE E IVA.

I PREZZI NON INCLUDONO INSTALLAZIONE E IVA

PER LA SCELTA DELL'ACCIAIO INOX, MAGGIORAZIONE DEL 5% SUL PREZZO DI LISTINO

PER PARTI INOX AGGIUNTA DEL 5% SUL PREZZO DI LISTINO

MOTORE MOTORE

■ 55/17, 85/17

BEAUFORT

*6 *7 *8 *9 *10



VERNICE RAL 8% SUL
LISTINO PER SCELTA FUORI DAI
7 STANDARD

VERNICE RAL 8% SUL PREZZO DI LISTINO PER
SELEZIONE TRA 7 STANDARD

FLOPER 140 CON RINFORZO E TRAVE

FLOPER 140 CON GRONDAIA E SUPPORTO TRAVE LATERALE

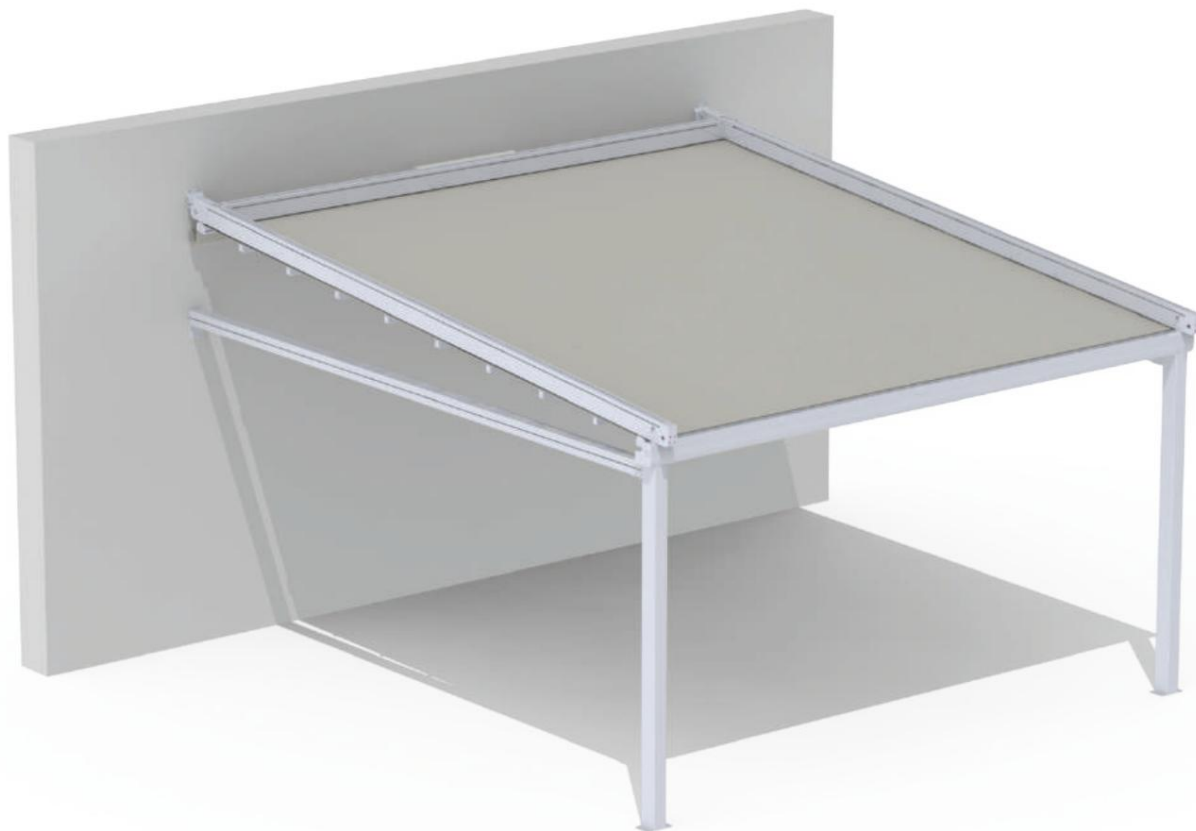

PER UN PIAZZOLINO SUPERIORE A 5 M, VENGONO INSTALLATE LATERALMENTE UNA TRAVE E UNA COLONNA 100X100.

PER SPORGENZE SUPERIORI A 5 M VIENE POSIZIONATA UNA COLONNA SULLA TRAVE LATERALE 100X100.

RACCORDI IN METALLO ZINCATO STANDARD
PARTI METALLICHE STANDARD ZINCATE

COLORI STANDARD



MOVIMENTO



LUCENTEZZA



ZABULINO DI ZIMIRELLA



TESSUTI TECNICI



ASSALE / ASSE	SCARICA / PROIEZIONE										
	2.50	3.00	3.50	4.00	4.50	5.00	5.50	6.00	6.50	7.00	7.50
2.50	€ 3.568y	€ 3.739y	€ 3.877y	€ 4.049y	€ 4.221y	€ 4.393y	€ 4.829y	€ 5.001y	€ 5.257y	€ 5.537y	€ 5.639y
3.00	€ 3.668y	€ 3.849y	€ 3.992y	€ 4.173y	€ 4.354y	€ 4.535y	€ 4.981y	€ 5.162y	€ 5.427y	€ 5.720y	€ 5.833y
3.50	€ 3.825y	€ 4.015y	€ 4.162y	€ 4.352y	€ 4.542y	€ 4.733y	€ 5.188y	€ 5.378y	€ 5.653y	€ 5.960y	€ 6.085y
4.00	€ 3.925y	€ 4.125y	€ 4.276y	€ 4.476y	€ 4.675y	€ 4.875y	€ 5.340y	€ 5.539y	€ 5.823y	€ 6.143y	€ 6.279y
4.50	€ 4.081y	€ 4.290y	€ 4.446y	€ 4.655y	€ 4.863y	€ 5.072y	€ 5.546y	€ 5.755y	€ 6.048y	€ 6.382y	€ 6.530y
5.00	€ 4.629y	€ 4.888y	€ 5.085y	€ 5.345y	€ 5.604y	€ 5.864y	€ 6.388y	€ 6.731y	€ 6.991y	€ 7.395y	€ 7.541y
5.50	€ 4.730y	€ 4.998y	€ 5.200y	€ 5.469y	€ 5.737y	€ 6.006y	€ 6.540y	€ 6.892y	€ 7.161y	€ 7.578y	€ 7.735y
6.00	€ 4.830y	€ 5.108y	€ 5.314y	€ 5.592y	€ 5.870y	€ 6.148y	€ 6.691y	€ 7.053y	€ 7.331y	€ 7.761y	€ 7.929y
6.50	€ 4.987y	€ 5.274y	€ 5.484y	€ 5.772y	€ 6.059y	€ 6.346y	€ 6.898y	€ 7.269y	€ 7.557y	€ 8.001y	€ 8.181y
7.00	€ 5.088y	€ 5.384y	€ 5.599y	€ 5.895y	€ 6.192y	€ 6.488y	€ 7.134y	€ 7.430y	€ 7.727y	€ 8.184y	€ 8.375y
7.50	€ 5.223y	€ 5.534y	€ 5.754y	€ 6.064y	€ 6.375y	€ 6.686y	€ 7.346y	€ 7.657y	€ 7.968y	€ 8.444y	€ 8.653y
8.00	€ 5.324y	€ 5.644y	€ 5.868y	€ 6.188y	€ 6.508y	€ 6.912y	€ 7.498y	€ 7.818y	€ 8.138y	€ 8.627y	€ 8.847y
8.50	€ 5.480y	€ 5.809y	€ 6.038y	€ 6.367y	€ 6.696y	€ 7.110y	€ 7.704y	€ 8.033y	€ 8.363y	€ 8.866y	€ 9.098y
9.00	€ 5.581y	€ 5.920y	€ 6.152y	€ 6.491y	€ 6.829y	€ 7.252y	€ 7.856y	€ 8.194y	€ 8.533y	€ 9.049y	€ 9.293y
9.50	€ 6.184y	€ 6.573y	€ 6.847y	€ 7.236y	€ 7.709y	€ 8.099y	€ 8.753y	€ 9.142y	€ 9.531y	€ 10.119y	€ 10.360y
10.00	€ 6.284y	€ 6.683y	€ 6.961y	€ 7.360y	€ 7.842y	€ 8.241y	€ 8.904y	€ 9.303y	€ 9.701y	€ 10.302y	€ 10.554y
10.50	€ 6.385y	€ 6.793y	€ 7.076y	€ 7.568y	€ 7.976y	€ 8.383y	€ 9.056y	€ 9.464y	€ 9.872y	€ 10.485y	€ 10.749y
11.00	€ 6.486y	€ 6.903y	€ 7.191y	€ 7.692y	€ 8.109y	€ 8.526y	€ 9.208y	€ 9.625y	€ 10.042y	€ 10.668y	€ 10.943y
11.50	€ 6.587y	€ 7.013y	€ 7.305y	€ 7.816y	€ 8.242y	€ 8.668y	€ 9.359y	€ 9.786y	€ 10.212y	€ 10.851y	€ 11.138y
12.00	€ 6.688y	€ 7.124y	€ 7.504y	€ 7.940y	€ 8.375y	€ 8.811y	€ 9.511y	€ 9.947y	€ 10.382y	€ 11.034y	€ 11.332y
12.50	€ 6.844y	€ 7.289y	€ 7.673y	€ 8.118y	€ 8.563y	€ 9.008y	€ 9.718y	€ 10.163y	€ 10.608y	€ 11.273y	€ 11.583y
13.00	€ 6.945y	€ 7.399y	€ 7.788y	€ 8.242y	€ 8.696y	€ 9.150y	€ 9.869y	€ 10.324y	€ 10.778y	€ 11.456y	€ 11.778y
13.50	€ 7.698y	€ 8.213y	€ 8.652y	€ 9.167y	€ 9.682y	€ 10.197y	€ 10.982y	€ 11.497y	€ 12.011y	€ 12.526y	€ 12.845y
14.00	€ 7.801y	€ 8.411y	€ 8.769y	€ 9.294y	€ 9.818y	€ 10.342y	€ 11.136y	€ 11.661y	€ 12.185y	€ 12.709y	€ 13.039y
14.50	€ 8.018y	€ 8.648y	€ 9.015y	€ 9.559y	€ 10.103y	€ 10.647y	€ 11.464y	€ 12.008y	€ 12.552y	€ 13.096y	€ 13.317y
15.00	€ 8.119y	€ 8.759y	€ 9.130y	€ 9.684y	€ 10.237y	€ 10.791y	€ 11.618y	€ 12.171y	€ 12.725y	€ 13.279y	€ 13.509y

I PREZZI INCLUDONO IL MOTORE - DRIVE BOX (SAFETY BOX)

I PREZZI INCLUDONO IL MOTORE (SAFETY BOX)

I PREZZI NON INCLUDONO INSTALLAZIONE E IVA.

I PREZZI NON INCLUDONO INSTALLAZIONE E IVA

PER LA SCELTA DELL'ACCIAIO INOX, MAGGIORAZIONE DEL 6% SUL PREZZO DI LISTINO

PER PARTI INOX AGGIUNTA DEL 6% SUL PREZZO DI LISTINO

MOTORE MOTORE

■ 55/17, 85/17

BEAUFORT

*6 *7 *8 *9 *10 



VERNICE RAL 8% SUL LISTINO PER SCELTA FUORI DAI 7 STANDARD

VERNICE RAL 8% SUL PREZZO DI LISTINO PER SELEZIONE TRA 7 STANDARD

FLOPER 140 CON CORDE

FLOPER 140 CON SUPPORTO CAVI



PER UNA DISCESA SUPERIORE A 5,5 M, VENGONO INSTALLATI 2 CAVI PER GUIDA.
PER SPORGENZE SUPERIORI A 5,5 M, SONO POSIZIONATI 2 CAVI PER GUIDA.



I CAVI E I RACCORDI METALLICI SONO ZINCATI.
IL SUPPORTO DEI CAVI E LE PARTI METALLICHE SONO ZINCATI.



MOVIMENTO

COLORI STANDARD

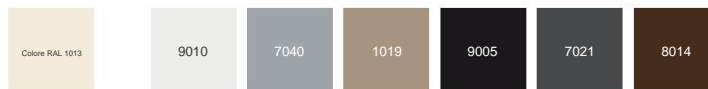

LUCENTEZZA

ZABULINO DI ZIMIRELLA



TESSUTI TECNICI



ASSALE / ASSE	SCARICA / PROIEZIONE										
	2.50	3.00	3.50	4.00	4.50	5.00	5.50	6.00	6.50	7.00	7.50
2.50	€ 2.860y	€ 3.033y	€ 3.135y	€ 3.270y	€ 3.449y	€ 3.632y	€ 3.841y	€ 4.303y	€ 4.598y	€ 4.869y	€ 4.953y
3.00	€ 2.938y	€ 3.118y	€ 3.225y	€ 3.369y	€ 3.555y	€ 3.744y	€ 3.960y	€ 4.426y	€ 4.727y	€ 5.001y	€ 5.093y
3.50	€ 3.070y	€ 3.257y	€ 3.368y	€ 3.522y	€ 3.715y	€ 3.912y	€ 4.134y	€ 4.605y	€ 4.913y	€ 5.191y	€ 5.289y
4.00	€ 3.149y	€ 3.343y	€ 3.459y	€ 3.622y	€ 3.822y	€ 4.025y	€ 4.252y	€ 4.728y	€ 5.041y	€ 5.320y	€ 5.425y
4.50	€ 3.309y	€ 3.510y	€ 3.631y	€ 3.804y	€ 4.011y	€ 4.221y	€ 4.453y	€ 4.934y	€ 5.253y	€ 5.535y	€ 5.646y
5.00	€ 3.786y	€ 4.043y	€ 4.210y	€ 4.437y	€ 4.700y	€ 4.966y	€ 5.256y	€ 6.001y	€ 6.299y	€ 6.649y	€ 6.760y
5.50	€ 3.869y	€ 4.132y	€ 4.304y	€ 4.541y	€ 4.809y	€ 5.081y	€ 5.373y	€ 6.120y	€ 6.421y	€ 6.769y	€ 6.884y
6.00	€ 3.953y	€ 4.222y	€ 4.398y	€ 4.645y	€ 4.919y	€ 5.196y	€ 5.491y	€ 6.238y	€ 6.543y	€ 6.887y	€ 7.006y
6.50	€ 4.105y	€ 4.380y	€ 4.562y	€ 4.818y	€ 5.098y	€ 5.380y	€ 5.677y	€ 6.426y	€ 6.734y	€ 7.075y	€ 7.197y
7.00	€ 4.190y	€ 4.471y	€ 4.657y	€ 4.924y	€ 5.209y	€ 5.495y	€ 5.878y	€ 6.543y	€ 6.853y	€ 7.191y	€ 7.315y
7.50	€ 4.324y	€ 4.616y	€ 4.807y	€ 5.089y	€ 5.384y	€ 5.680y	€ 6.069y	€ 6.739y	€ 7.057y	€ 7.395y	€ 7.526y
8.00	€ 4.410y	€ 4.708y	€ 4.904y	€ 5.195y	€ 5.495y	€ 5.879y	€ 6.186y	€ 6.855y	€ 7.175y	€ 7.507y	€ 7.640y
8.50	€ 4.607y	€ 4.911y	€ 5.112y	€ 5.414y	€ 5.718y	€ 6.107y	€ 6.413y	€ 7.081y	€ 7.403y	€ 7.729y	€ 7.863y
9.00	€ 4.695y	€ 5.004y	€ 5.210y	€ 5.522y	€ 5.831y	€ 6.223y	€ 6.533y	€ 7.210y	€ 7.541y	€ 7.876y	€ 8.020y
9.50	€ 5.236y	€ 5.597y	€ 5.850y	€ 6.218y	€ 6.661y	€ 7.018y	€ 7.380y	€ 8.246y	€ 8.648y	€ 9.064y	€ 9.216y
10.00	€ 5.327y	€ 5.692y	€ 5.951y	€ 6.330y	€ 6.776y	€ 7.136y	€ 7.503y	€ 8.392y	€ 8.813y	€ 9.258y	€ 9.430y
10.50	€ 5.418y	€ 5.788y	€ 6.052y	€ 6.526y	€ 6.891y	€ 7.254y	€ 7.627y	€ 8.539y	€ 8.979y	€ 9.454y	€ 9.646y
11.00	€ 5.524y	€ 5.899y	€ 6.168y	€ 6.653y	€ 7.021y	€ 7.386y	€ 7.765y	€ 8.700y	€ 9.159y	€ 9.665y	€ 9.877y
11.50	€ 5.616y	€ 5.996y	€ 6.271y	€ 6.766y	€ 7.137y	€ 7.505y	€ 7.889y	€ 8.847y	€ 9.327y	€ 9.864y	€ 10.097y
12.00	€ 5.709y	€ 6.094y	€ 6.459y	€ 6.880y	€ 7.254y	€ 7.623y	€ 8.013y	€ 8.996y	€ 9.495y	€ 10.064y	€ 10.318y
12.50	€ 5.946y	€ 6.335y	€ 6.705y	€ 7.137y	€ 7.513y	€ 7.883y	€ 8.277y	€ 9.286y	€ 9.807y	€ 10.410y	€ 10.687y
13.00	€ 6.041y	€ 6.434y	€ 6.810y	€ 7.252y	€ 7.631y	€ 8.002y	€ 8.401y	€ 9.435y	€ 9.978y	€ 10.614y	€ 10.913y
13.50	€ 6.559y	€ 7.000y	€ 7.425y	€ 7.925y	€ 8.348y	€ 8.762y	€ 9.210y	€ 10.448y	€ 11.073y	€ 11.815y	€ 12.133y
14.00	€ 6.656y	€ 7.187y	€ 7.532y	€ 8.043y	€ 8.468y	€ 8.882y	€ 9.335y	€ 10.600y	€ 11.248y	€ 12.026y	€ 12.369y
14.50	€ 6.820y	€ 7.360y	€ 7.710y	€ 8.238y	€ 8.668y	€ 9.087y	€ 9.548y	€ 10.849y	€ 11.525y	€ 12.348y	€ 12.722y
15.00	€ 6.919y	€ 7.463y	€ 7.818y	€ 8.357y	€ 8.789y	€ 9.208y	€ 9.674y	€ 11.002y	€ 11.702y	€ 12.564y	€ 12.962y

PER PARTI INOX AGGIUNTA 11% SUL PREZZO DI LISTINO PER SPORGENZE INFERIORI A 5,50 M. E 22% PER SPORGENZE SUPERIORI A 5,50 M.

I PREZZI INCLUDONO IL MOTORE - DRIVE BOX (SAFETY BOX)

I PREZZI INCLUDONO IL MOTORE (SAFETY BOX)

I PREZZI NON INCLUDONO INSTALLAZIONE E IVA.

I PREZZI NON INCLUDONO INSTALLAZIONE E IVA

MOTORE MOTORE

■ 55/17, 85/17

BEAUFORT

*6 *7 *8 *9 *10



VERNICE RAL 8% SUL

LISTINO PER SCELTA FUORI DAI 7

STANDARD

VERNICE RAL 8% SUL LISTINO PREZZI

PER LA SELEZIONE TRA 7 STANDARD

40 FIORI FINE SHADING

FLOPER 140 TELAIO AUTOPORTANTE

FLOPER 140 TELAIO AUTOPORTANTE



RACCORDI IN METALLO ZINCATO STANDARD
PARTI METALLICHE STANDARD ZINCATE

COLORI STANDARD



MOVIMENTO



LUCENTEZZA



ZABULINO DI ZIMIRELLA



TESSUTI TECNICI



ASSALE / ASSE	SCARICA / PROIEZIONE										
	2.50	3.00	3.50	4.00	4.50	5.00	5.50	6.00	6.50	7.00	7.50
2.50	€ 5.538y	€ 5.853y	€ 6.062y	€ 6.304y	€ 6.725y	€ 7.060y	€ 7.447y	€ 7.843y	€ 8.318y	€ 8.786y	€ 9.021y
3.00	€ 5.739y	€ 6.060y	€ 6.274y	€ 6.526y	€ 6.953y	€ 7.293y	€ 7.682y	€ 8.081y	€ 8.560y	€ 9.026y	€ 9.266y
3.50	€ 5.996y	€ 6.323y	€ 6.542y	€ 6.804y	€ 7.237y	€ 7.582y	€ 7.975y	€ 8.376y	€ 8.858y	€ 9.323y	€ 9.567y
4.00	€ 6.200y	€ 6.533y	€ 6.757y	€ 7.029y	€ 7.467y	€ 7.816y	€ 8.210y	€ 8.612y	€ 9.097y	€ 9.558y	€ 9.805y
4.50	€ 6.460y	€ 6.798y	€ 7.027y	€ 7.309y	€ 7.753y	€ 8.107y	€ 8.501y	€ 8.903y	€ 9.391y	€ 9.849y	€ 10.098y
5.00	€ 7.566y	€ 7.958y	€ 8.229y	€ 8.562y	€ 9.059y	€ 9.466y	€ 9.916y	€ 10.460y	€ 10.915y	€ 11.429y	€ 11.666y
5.50	€ 7.778y	€ 8.174y	€ 8.450y	€ 8.794y	€ 9.293y	€ 9.703y	€ 10.150y	€ 10.690y	€ 11.145y	€ 11.649y	€ 11.886y
6.00	€ 7.992y	€ 8.391y	€ 8.673y	€ 9.027y	€ 9.529y	€ 9.940y	€ 10.383y	€ 10.919y	€ 11.373y	€ 11.866y	€ 12.102y
6.50	€ 8.277y	€ 8.679y	€ 8.966y	€ 9.331y	€ 9.835y	€ 10.248y	€ 10.687y	€ 11.219y	€ 11.672y	€ 12.153y	€ 12.388y
7.00	€ 8.494y	€ 8.899y	€ 9.192y	€ 9.567y	€ 10.073y	€ 10.486y	€ 11.007y	€ 11.446y	€ 11.897y	€ 12.365y	€ 12.597y
7.50	€ 8.748y	€ 9.161y	€ 9.459y	€ 9.849y	€ 10.362y	€ 10.781y	€ 11.301y	€ 11.739y	€ 12.193y	€ 12.652y	€ 12.887y
8.00	€ 8.969y	€ 9.383y	€ 9.686y	€ 10.088y	€ 10.601y	€ 11.105y	€ 11.534y	€ 11.964y	€ 12.415y	€ 12.858y	€ 13.089y
8.50	€ 9.246y	€ 9.663y	€ 9.972y	€ 10.383y	€ 10.897y	€ 11.401y	€ 11.822y	€ 12.244y	€ 12.691y	€ 13.118y	€ 13.345y
9.00	€ 9.470y	€ 9.888y	€ 10.202y	€ 10.624y	€ 11.138y	€ 11.641y	€ 12.060y	€ 12.492y	€ 12.949y	€ 13.385y	€ 13.621y
9.50	€ 10.684y	€ 11.144y	€ 11.501y	€ 11.977y	€ 12.618y	€ 13.073y	€ 13.537y	€ 14.043y	€ 14.568y	€ 15.088y	€ 15.330y
10.00	€ 10.914y	€ 11.374y	€ 11.737y	€ 12.224y	€ 12.863y	€ 13.315y	€ 13.782y	€ 14.319y	€ 14.870y	€ 15.433y	€ 15.701y
10.50	€ 11.146y	€ 11.606y	€ 11.975y	€ 12.559y	€ 13.109y	€ 13.558y	€ 14.028y	€ 14.597y	€ 15.174y	€ 15.781y	€ 16.076y
11.00	€ 11.380y	€ 11.838y	€ 12.213y	€ 12.809y	€ 13.356y	€ 13.801y	€ 14.273y	€ 14.876y	€ 15.480y	€ 16.131y	€ 16.453y
11.50	€ 11.615y	€ 12.072y	€ 12.452y	€ 13.060y	€ 13.604y	€ 14.044y	€ 14.519y	€ 15.156y	€ 15.787y	€ 16.483y	€ 16.835y
12.00	€ 11.851y	€ 12.307y	€ 12.781y	€ 13.312y	€ 13.853y	€ 14.289y	€ 14.765y	€ 15.437y	€ 16.095y	€ 16.839y	€ 17.219y
12.50	€ 12.162y	€ 12.615y	€ 13.095y	€ 13.637y	€ 14.174y	€ 14.604y	€ 15.082y	€ 15.789y	€ 16.477y	€ 17.270y	€ 17.680y
13.00	€ 12.401y	€ 12.853y	€ 13.339y	€ 13.892y	€ 14.425y	€ 14.849y	€ 15.328y	€ 16.072y	€ 16.789y	€ 17.630y	€ 18.072y
13.50	€ 13.663y	€ 14.146y	€ 14.677y	€ 15.285y	€ 15.846y	€ 16.295y	€ 16.813y	€ 17.654y	€ 18.456y	€ 19.417y	€ 19.879y
14.00	€ 13.909y	€ 14.478y	€ 14.926y	€ 15.546y	€ 16.100y	€ 16.542y	€ 17.061y	€ 17.942y	€ 18.775y	€ 19.790y	€ 20.285y
14.50	€ 14.195y	€ 14.765y	€ 15.219y	€ 15.856y	€ 16.409y	€ 16.847y	€ 17.371y	€ 18.298y	€ 19.170y	€ 20.248y	€ 20.783y
15.00	€ 14.442y	€ 15.008y	€ 15.468y	€ 16.117y	€ 16.663y	€ 17.093y	€ 17.616y	€ 18.585y	€ 19.490y	€ 20.624y	€ 21.194y

I PREZZI INCLUDONO IL MOTORE - DRIVE BOX (SAFETY BOX)

I PREZZI INCLUDONO IL MOTORE (SAFETY BOX)

I PREZZI NON INCLUDONO INSTALLAZIONE E IVA.

I PREZZI NON INCLUDONO INSTALLAZIONE E IVA

PER LA SCELTA DELL'ACCIAIO INOX, MAGGIORAZIONE DEL 6% SUL PREZZO DI LISTINO

PER PARTI INOX AGGIUNTA DEL 6% SUL PREZZO DI LISTINO

MOTORE MOTORE

■ 55/17, 85/17

BEAUFORT

*6 *7 *8 *9 *10



VERNICE RAL 8% SUL
LISTINO PER SCELTA FUORI DAI
7 STANDARD

VERNICE RAL 8% SUL PREZZO DI LISTINO PER
SELEZIONE TRA 7 STANDARD

FLOPER 140 TELAIO DA PARETE

FLOPER 140 TELAIO MONTAGGIO A PARETE

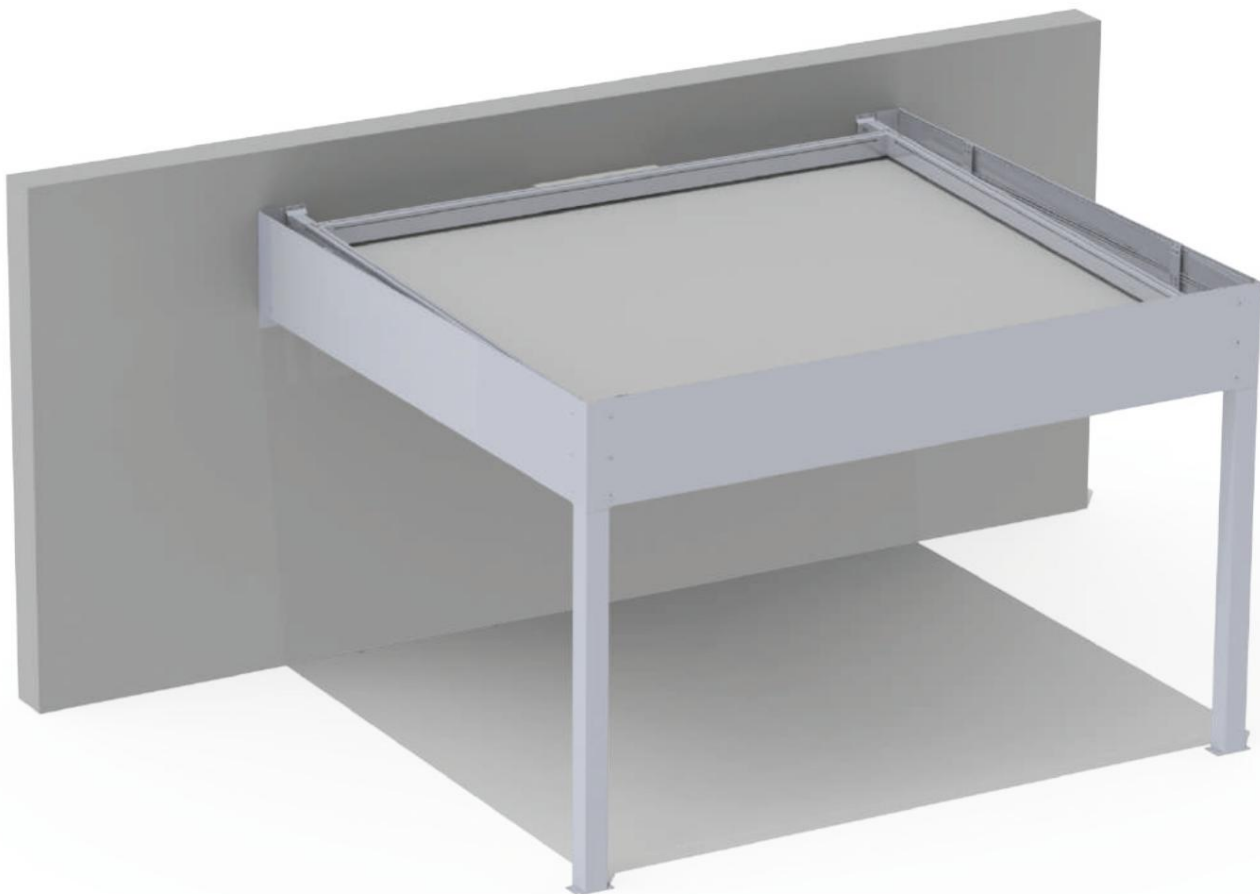

RACCORDI IN METALLO ZINCATO STANDARD
PARTI METALLICHE STANDARD ZINCATE

COLORI STANDARD



MOVIMENTO



LUCENTEZZA



ZABULINO DI ZIMIRELLA



TESSUTI TECNICI



ASSALE / ASSE	SCARICA / PROIEZIONE										
	2.50	3.00	3.50	4.00	4.50	5.00	5.50	6.00	6.50	7.00	7.50
2.50	€ 4.815y	€ 5.120y	€ 5.329y	€ 5.571y	€ 5.983y	€ 6.308y	€ 6.680y	€ 7.063y	€ 7.528y	€ 7.976y	€ 8.202y
3.00	€ 4.956y	€ 5.268y	€ 5.482y	€ 5.734y	€ 6.151y	€ 6.482y	€ 6.857y	€ 7.242y	€ 7.711y	€ 8.158y	€ 8.388y
3.50	€ 5.153y	€ 5.471y	€ 5.690y	€ 5.952y	€ 6.376y	€ 6.712y	€ 7.090y	€ 7.478y	€ 7.951y	€ 8.397y	€ 8.632y
4.00	€ 5.297y	€ 5.621y	€ 5.845y	€ 6.117y	€ 6.546y	€ 6.886y	€ 7.267y	€ 7.655y	€ 8.131y	€ 8.575y	€ 8.812y
4.50	€ 5.496y	€ 5.826y	€ 6.055y	€ 6.337y	€ 6.772y	€ 7.117y	€ 7.499y	€ 7.889y	€ 8.368y	€ 8.808y	€ 9.049y
5.00	€ 6.261y	€ 6.642y	€ 6.914y	€ 7.247y	€ 7.734y	€ 8.131y	€ 8.565y	€ 9.095y	€ 9.539y	€ 10.033y	€ 10.260y
5.50	€ 6.410y	€ 6.797y	€ 7.073y	€ 7.417y	€ 7.907y	€ 8.307y	€ 8.741y	€ 9.267y	€ 9.713y	€ 10.199y	€ 10.427y
6.00	€ 6.561y	€ 6.952y	€ 7.233y	€ 7.587y	€ 8.081y	€ 8.484y	€ 8.916y	€ 9.440y	€ 9.885y	€ 10.362y	€ 10.591y
6.50	€ 6.782y	€ 7.177y	€ 7.464y	€ 7.829y	€ 8.326y	€ 8.732y	€ 9.161y	€ 9.682y	€ 10.128y	€ 10.596y	€ 10.824y
7.00	€ 6.934y	€ 7.334y	€ 7.626y	€ 8.001y	€ 8.502y	€ 8.909y	€ 9.422y	€ 9.853y	€ 10.298y	€ 10.755y	€ 10.982y
7.50	€ 7.124y	€ 7.532y	€ 7.830y	€ 8.221y	€ 8.729y	€ 9.144y	€ 9.658y	€ 10.090y	€ 10.540y	€ 10.991y	€ 11.222y
8.00	€ 7.279y	€ 7.691y	€ 7.994y	€ 8.395y	€ 8.906y	€ 9.408y	€ 9.832y	€ 10.259y	€ 10.707y	€ 11.145y	€ 11.374y
8.50	€ 7.491y	€ 7.907y	€ 8.215y	€ 8.627y	€ 9.140y	€ 9.643y	€ 10.063y	€ 10.483y	€ 10.930y	€ 11.354y	€ 11.580y
9.00	€ 7.648y	€ 8.067y	€ 8.381y	€ 8.804y	€ 9.318y	€ 9.822y	€ 10.242y	€ 10.672y	€ 11.128y	€ 11.562y	€ 11.798y
9.50	€ 8.505y	€ 8.968y	€ 9.326y	€ 9.802y	€ 10.445y	€ 10.904y	€ 11.370y	€ 11.870y	€ 12.392y	€ 12.906y	€ 13.144y
10.00	€ 8.667y	€ 9.133y	€ 9.496y	€ 9.983y	€ 10.627y	€ 11.085y	€ 11.555y	€ 12.083y	€ 12.629y	€ 13.180y	€ 13.443y
10.50	€ 8.831y	€ 9.298y	€ 9.667y	€ 10.251y	€ 10.809y	€ 11.266y	€ 11.740y	€ 12.297y	€ 12.866y	€ 13.457y	€ 13.744y
11.00	€ 8.995y	€ 9.464y	€ 9.838y	€ 10.434y	€ 10.992y	€ 11.447y	€ 11.925y	€ 12.512y	€ 13.105y	€ 13.735y	€ 14.047y
11.50	€ 9.160y	€ 9.631y	€ 10.011y	€ 10.618y	€ 11.176y	€ 11.629y	€ 12.110y	€ 12.727y	€ 13.345y	€ 14.015y	€ 14.353y
12.00	€ 9.326y	€ 9.798y	€ 10.272y	€ 10.803y	€ 11.360y	€ 11.812y	€ 12.296y	€ 12.943y	€ 13.586y	€ 14.298y	€ 14.662y
12.50	€ 9.566y	€ 10.039y	€ 10.518y	€ 11.060y	€ 11.616y	€ 12.065y	€ 12.552y	€ 13.231y	€ 13.900y	€ 14.655y	€ 15.047y
13.00	€ 9.734y	€ 10.208y	€ 10.693y	€ 11.247y	€ 11.802y	€ 12.248y	€ 12.738y	€ 13.449y	€ 14.144y	€ 14.942y	€ 15.361y
13.50	€ 10.625y	€ 11.136y	€ 11.667y	€ 12.275y	€ 12.863y	€ 13.341y	€ 13.872y	€ 14.672y	€ 15.446y	€ 16.351y	€ 16.786y
14.00	€ 10.798y	€ 11.398y	€ 11.846y	€ 12.466y	€ 13.052y	€ 13.525y	€ 14.059y	€ 14.893y	€ 15.695y	€ 16.647y	€ 17.111y
14.50	€ 11.010y	€ 11.614y	€ 12.069y	€ 12.706y	€ 13.294y	€ 13.767y	€ 14.308y	€ 15.183y	€ 16.020y	€ 17.028y	€ 17.528y
15.00	€ 11.183y	€ 11.787y	€ 12.248y	€ 12.896y	€ 13.481y	€ 13.950y	€ 14.493y	€ 15.404y	€ 16.269y	€ 17.326y	€ 17.857y

I PREZZI INCLUDONO IL MOTORE - DRIVE BOX (SAFETY BOX)

I PREZZI INCLUDONO IL MOTORE (SAFETY BOX)

I PREZZI NON INCLUDONO INSTALLAZIONE E IVA.

I PREZZI NON INCLUDONO INSTALLAZIONE E IVA

PER PARTI INOX AGGIUNTA DEL 5,5% SUL PREZZO DI LISTINO

MOTORE MOTORE

■ 55/17, 85/17

BEAUFORT

*6 *7 *8 *9 *10



VERNICE RAL 8% SUL

LISTINO PER SCELTA FUORI DAI 7

STANDARD

VERNICE RAL 8% SUL PREZZO DI LISTINO PER

SELEZIONE TRA 7 STANDARD

TELAIO FLOPER 140



RACCORDI IN METALLO ZINCATO STANDARD
PARTI METALLICHE STANDARD ZINCATE

COLORI STANDARD



MOVIMENTO



LUCENTEZZA



ZABULINO DI ZIMIRELLA



TESSUTI TECNICI



ASSALE / ASSE	SCARICA / PROIEZIONE										
	2.50	3.00	3.50	4.00	4.50	5.00	5.50	6.00	6.50	7.00	7.50
2.50	€ 4.617y	€ 4.919y	€ 5.128y	€ 5.370y	€ 5.779y	€ 6.102y	€ 6.470y	€ 6.849y	€ 7.311y	€ 7.755y	€ 7.978y
3.00	€ 4.814y	€ 5.123y	€ 5.337y	€ 5.589y	€ 6.005y	€ 6.334y	€ 6.706y	€ 7.088y	€ 7.556y	€ 8.000y	€ 8.228y
3.50	€ 5.066y	€ 5.384y	€ 5.602y	€ 5.864y	€ 6.287y	€ 6.622y	€ 6.999y	€ 7.385y	€ 7.857y	€ 8.302y	€ 8.536y
4.00	€ 5.266y	€ 5.590y	€ 5.814y	€ 6.086y	€ 6.515y	€ 6.855y	€ 7.235y	€ 7.623y	€ 8.099y	€ 8.542y	€ 8.779y
4.50	€ 5.522y	€ 5.853y	€ 6.082y	€ 6.364y	€ 6.799y	€ 7.144y	€ 7.527y	€ 7.917y	€ 8.396y	€ 8.837y	€ 9.078y
5.00	€ 6.160y	€ 6.541y	€ 6.813y	€ 7.146y	€ 7.632y	€ 8.028y	€ 8.462y	€ 8.990y	€ 9.434y	€ 9.926y	€ 10.152y
5.50	€ 6.367y	€ 6.753y	€ 7.030y	€ 7.373y	€ 7.864y	€ 8.263y	€ 8.696y	€ 9.223y	€ 9.668y	€ 10.153y	€ 10.381y
6.00	€ 6.575y	€ 6.966y	€ 7.248y	€ 7.602y	€ 8.096y	€ 8.499y	€ 8.930y	€ 9.455y	€ 9.901y	€ 10.377y	€ 10.606y
6.50	€ 6.854y	€ 7.250y	€ 7.537y	€ 7.902y	€ 8.400y	€ 8.805y	€ 9.235y	€ 9.757y	€ 10.203y	€ 10.672y	€ 10.900y
7.00	€ 7.066y	€ 7.466y	€ 7.758y	€ 8.133y	€ 8.634y	€ 9.042y	€ 9.555y	€ 9.987y	€ 10.433y	€ 10.891y	€ 11.118y
7.50	€ 7.314y	€ 7.723y	€ 8.021y	€ 8.411y	€ 8.920y	€ 9.335y	€ 9.851y	€ 10.283y	€ 10.733y	€ 11.185y	€ 11.417y
8.00	€ 7.529y	€ 7.941y	€ 8.244y	€ 8.645y	€ 9.157y	€ 9.659y	€ 10.084y	€ 10.511y	€ 10.960y	€ 11.398y	€ 11.628y
8.50	€ 7.801y	€ 8.216y	€ 8.525y	€ 8.937y	€ 9.450y	€ 9.953y	€ 10.373y	€ 10.794y	€ 11.240y	€ 11.665y	€ 11.892y
9.00	€ 8.018y	€ 8.437y	€ 8.751y	€ 9.174y	€ 9.688y	€ 10.191y	€ 10.611y	€ 11.041y	€ 11.498y	€ 11.932y	€ 12.168y
9.50	€ 8.745y	€ 9.208y	€ 9.566y	€ 10.041y	€ 10.685y	€ 11.143y	€ 11.609y	€ 12.110y	€ 12.632y	€ 13.147y	€ 13.385y
10.00	€ 8.968y	€ 9.432y	€ 9.796y	€ 10.282y	€ 10.926y	€ 11.383y	€ 11.853y	€ 12.383y	€ 12.928y	€ 13.482y	€ 13.745y
10.50	€ 9.192y	€ 9.658y	€ 10.027y	€ 10.612y	€ 11.168y	€ 11.624y	€ 12.097y	€ 12.657y	€ 13.227y	€ 13.820y	€ 14.108y
11.00	€ 9.418y	€ 9.885y	€ 10.260y	€ 10.856y	€ 11.412y	€ 11.865y	€ 12.342y	€ 12.931y	€ 13.526y	€ 14.160y	€ 14.474y
11.50	€ 9.645y	€ 10.113y	€ 10.493y	€ 11.101y	€ 11.656y	€ 12.107y	€ 12.587y	€ 13.207y	€ 13.828y	€ 14.503y	€ 14.844y
12.00	€ 9.874y	€ 10.343y	€ 10.816y	€ 11.347y	€ 11.901y	€ 12.349y	€ 12.832y	€ 13.484y	€ 14.131y	€ 14.849y	€ 15.217y
12.50	€ 10.177y	€ 10.645y	€ 11.124y	€ 11.667y	€ 12.218y	€ 12.662y	€ 13.148y	€ 13.833y	€ 14.507y	€ 15.270y	€ 15.666y
13.00	€ 10.408y	€ 10.877y	€ 11.362y	€ 11.916y	€ 12.465y	€ 12.905y	€ 13.393y	€ 14.112y	€ 14.813y	€ 15.621y	€ 16.046y
13.50	€ 11.166y	€ 11.672y	€ 12.203y	€ 12.811y	€ 13.394y	€ 13.867y	€ 14.396y	€ 15.203y	€ 15.982y	€ 16.897y	€ 17.337y
14.00	€ 11.403y	€ 11.996y	€ 12.445y	€ 13.065y	€ 13.644y	€ 14.111y	€ 14.642y	€ 15.486y	€ 16.294y	€ 17.258y	€ 17.728y
14.50	€ 11.678y	€ 12.276y	€ 12.730y	€ 13.367y	€ 13.948y	€ 14.414y	€ 14.951y	€ 15.837y	€ 16.682y	€ 17.704y	€ 18.211y
15.00	€ 11.916y	€ 12.512y	€ 12.972y	€ 13.621y	€ 14.197y	€ 14.657y	€ 15.196y	€ 16.120y	€ 16.994y	€ 18.068y	€ 18.608y

I PREZZI INCLUDONO IL MOTORE - DRIVE BOX (SAFETY BOX)

I PREZZI INCLUDONO IL MOTORE (SAFETY BOX)

I PREZZI NON INCLUDONO INSTALLAZIONE E IVA.

I PREZZI NON INCLUDONO INSTALLAZIONE E IVA

PER LA SCELTA DELL'ACCIAIO INOX, MAGGIORAZIONE DEL 5% SUL PREZZO DI LISTINO

PER PARTI INOX AGGIUNTA DEL 5% SUL PREZZO DI LISTINO

MOTORE MOTORE

■ 55/17, 85/17

BEAUFORT

*6 *7 *8 *9 *10 



VERNICE RAL 8% SUL LISTINO PER SCELTA FUORI DAI 7 STANDARD

VERNICE RAL 8% SUL PREZZO DI LISTINO PER SELEZIONE TRA 7 STANDARD

FLOPER 140 SPACE AUTO SUPPORT

FLOPER 140 SPAZIO AUTOPORTANTE

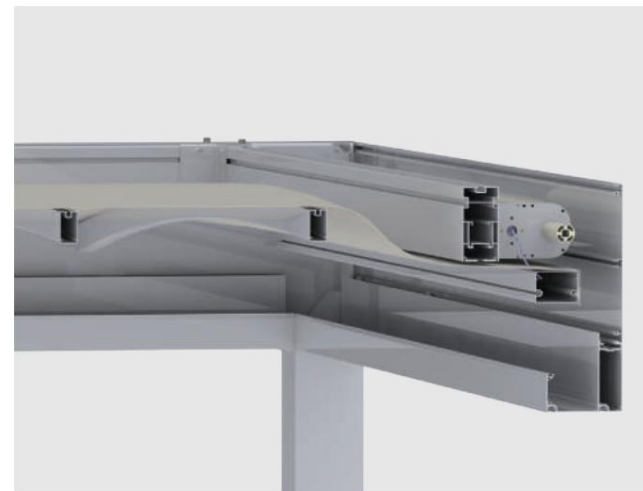

RACCORDI IN METALLO ZINCATO STANDARD
PARTI METALLICHE STANDARD ZINCATE

COLORI STANDARD



MOVIMENTO



LUCENTEZZA



ZABULINO DI ZIMIRELLA



TESSUTI TECNICI





BASE A COLONNA TELESCOPICA
BASE A COLONNA REGOLABILE



BASE PER COLONNA INCASSATA
BASE PER COLONNA INCASSATA

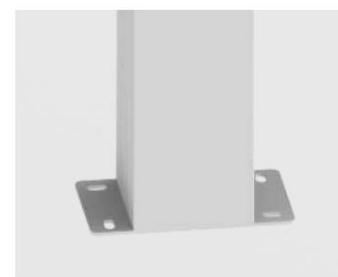

BASE PER COLONNA STANDARD
BASE PER COLONNA STANDARD

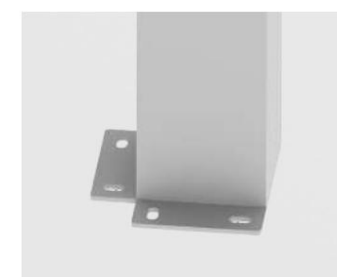

BASE COLONNA ANGOLARE
BASE DELLA COLONNA ANGOLATA

ASSE / ASSE	SCARICA / PROIEZIONE									
	2.50	3.00	3.50	4.00	4.50	5.00	5.50	6.00	6.50	7.00
2.50	€ 6.503ÿ	€ 6.796ÿ	€ 7.089ÿ	€ 7.276ÿ	€ 7.665ÿ	€ 7.958ÿ	€ 8.761ÿ	€ 9.054ÿ	€ 9.288ÿ	€ 9.601ÿ
3.00	€ 6.680ÿ	€ 6.988ÿ	€ 7.295ÿ	€ 7.487ÿ	€ 7.889ÿ	€ 8.196ÿ	€ 9.028ÿ	€ 9.340ÿ	€ 9.561ÿ	€ 9.889ÿ
3.50	€ 6.914ÿ	€ 7.235ÿ	€ 7.556ÿ	€ 7.753ÿ	€ 8.170ÿ	€ 8.508ÿ	€ 9.352ÿ	€ 9.679ÿ	€ 9.909ÿ	€ 10.232ÿ
4.00	€ 7.091ÿ	€ 7.427ÿ	€ 7.763ÿ	€ 7.964ÿ	€ 8.407ÿ	€ 8.756ÿ	€ 9.610ÿ	€ 9.947ÿ	€ 10.183ÿ	€ 10.520ÿ
4.50	€ 7.324ÿ	€ 7.674ÿ	€ 8.024ÿ	€ 8.229ÿ	€ 8.692ÿ	€ 9.052ÿ	€ 9.920ÿ	€ 10.271ÿ	€ 10.511ÿ	€ 10.863ÿ
5.00	€ 7.502ÿ	€ 7.866ÿ	€ 8.230ÿ	€ 8.440ÿ	€ 8.931ÿ	€ 9.310ÿ	€ 10.189ÿ	€ 10.555ÿ	€ 10.785ÿ	€ 11.151ÿ
5.50	€ 7.735ÿ	€ 8.113ÿ	€ 8.491ÿ	€ 8.706ÿ	€ 9.212ÿ	€ 9.606ÿ	€ 10.499ÿ	€ 10.880ÿ	€ 11.114ÿ	€ 11.494ÿ

I PREZZI INCLUDONO IL MOTORE - DRIVE BOX (SAFETY BOX)

I PREZZI INCLUDONO IL MOTORE (SAFETY BOX)

I PREZZI NON INCLUDONO INSTALLAZIONE E IVA.

I PREZZI NON INCLUDONO INSTALLAZIONE E IVA

PER LA SCELTA DELL'ACCIAIO INOX, MAGGIORAZIONE DEL 6% SUL PREZZO DI LISTINO

PER PARTI INOX AGGIUNTA DEL 6% SUL PREZZO DI LISTINO

MOTORE MOTORE

85/17

BEAUFORT

°7 °8 °9 °10 

VERNICE RAL 8% SUL LISTINO

PER SCELTA FUORI DAI 7 STANDARD



VERNICE RAL 8% SUL PREZZO DI LISTINO PER

SELEZIONE TRA 7 STANDARD

FLOPER 140 SPACE MONTATO A PARETE

FLOPER 140 SPACE MONTAGGIO A PARETE

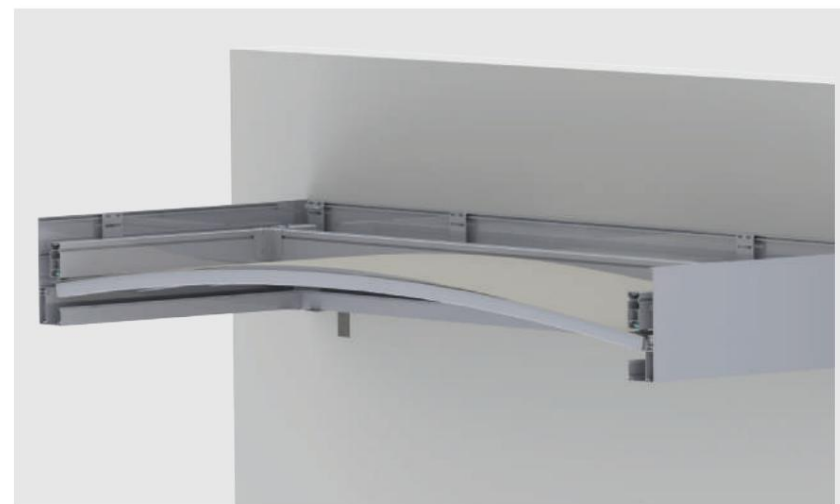

RACCORDI IN METALLO ZINCATO STANDARD
PARTI METALLICHE STANDARD ZINCATE



MOVIMENTO

COLORI STANDARD

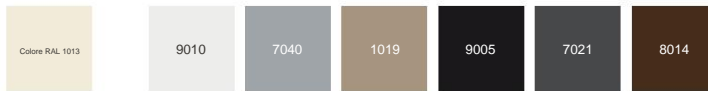

LUCENTEZZA

ZABULINO DI ZIMIRELLA



TESSUTI TECNICI



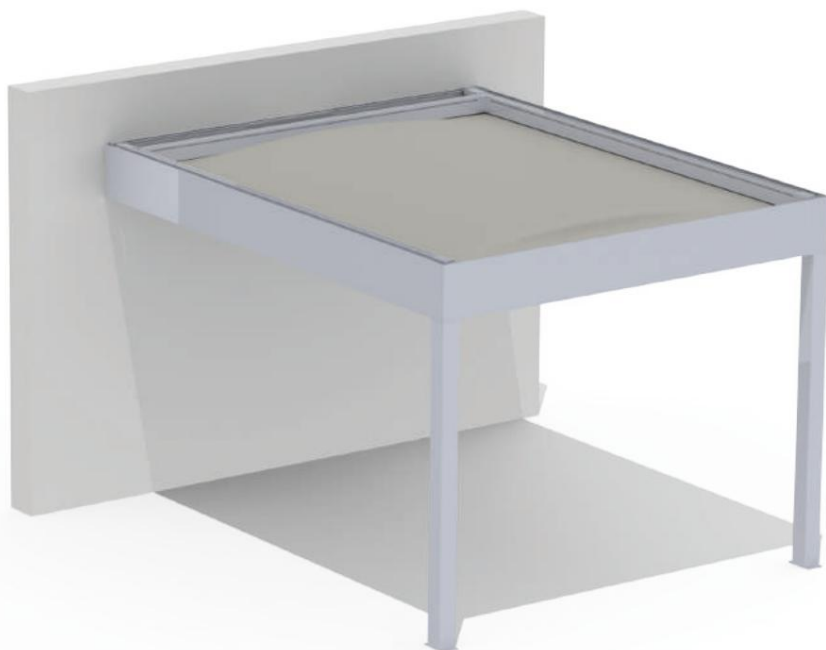

ASSE / ASSE	SCARICA / PROIEZIONE									
	2.50	3.00	3.50	4.00	4.50	5.00	5.50	6.00	6.50	7.00
2.50	€ 6.004y	€ 6.297y	€ 6.589y	€ 6.777y	€ 7.166y	€ 7.458y	€ 8.262y	€ 8.555y	€ 8.788y	€ 9.099y
3.00	€ 6.181y	€ 6.488y	€ 6.795y	€ 6.988y	€ 7.390y	€ 7.697y	€ 8.528y	€ 8.840y	€ 9.060y	€ 9.387y
3.50	€ 6.415y	€ 6.736y	€ 7.057y	€ 7.254y	€ 7.671y	€ 8.008y	€ 8.851y	€ 9.178y	€ 9.408y	€ 9.731y
4.00	€ 6.592y	€ 6.928y	€ 7.263y	€ 7.464y	€ 7.907y	€ 8.256y	€ 9.109y	€ 9.446y	€ 9.681y	€ 10.018y
4.50	€ 6.825y	€ 7.175y	€ 7.525y	€ 7.730y	€ 8.192y	€ 8.551y	€ 9.419y	€ 9.770y	€ 10.010y	€ 10.361y
5.00	€ 7.003y	€ 7.367y	€ 7.731y	€ 7.941y	€ 8.430y	€ 8.808y	€ 9.688y	€ 10.054y	€ 10.283y	€ 10.649y
5.50	€ 7.236y	€ 7.614y	€ 7.992y	€ 8.207y	€ 8.711y	€ 9.104y	€ 9.998y	€ 10.378y	€ 10.612y	€ 10.992y

I PREZZI INCLUDONO IL MOTORE - DRIVE BOX (SAFETY BOX)

I PREZZI INCLUDONO IL MOTORE (SAFETY BOX)

I PREZZI NON INCLUDONO INSTALLAZIONE E IVA.

I PREZZI NON INCLUDONO INSTALLAZIONE E IVA

PER PARTI INOX AGGIUNTA DEL 5,5% SUL PREZZO DI LISTINO

MOTORE MOTORE

85/17

BEAUFORT

*7 *8 *9 *10 



VERNICE RAL 8% SUL
LISTINO PER SCELTA FUORI DAI 7
STANDARD

VERNICE RAL 8% SUL PREZZO DI LISTINO PER
SELEZIONE TRA 7 STANDARD

50 FIORI FINE SHADING

FLOPER 140 SPAZIO



RACCORDI IN METALLO ZINCATO STANDARD
PARTI METALLICHE STANDARD ZINCATE



MOVIMENTO

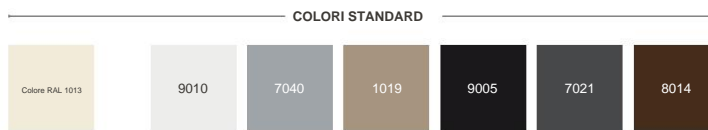

LUCENTEZZA

ZABULINO DI ZIMIRELLA



TESSUTI TECNICI





ASSE / ASSE	SCARICA / PROIEZIONE									
	2.50	3.00	3.50	4.00	4.50	5.00	5.50	6.00	6.50	7.00
2.50	€ 5.342 ^y	€ 5.633 ^y	€ 5.923 ^y	€ 6.110 ^y	€ 6.495 ^y	€ 6.786 ^y	€ 7.077 ^y	€ 7.368 ^y	€ 7.595 ^y	€ 7.902 ^y
3.00	€ 5.518 ^y	€ 5.823 ^y	€ 6.128 ^y	€ 6.319 ^y	€ 6.719 ^y	€ 7.023 ^y	€ 7.339 ^y	€ 7.648 ^y	€ 7.866 ^y	€ 8.188 ^y
3.50	€ 5.750 ^y	€ 6.069 ^y	€ 6.388 ^y	€ 6.583 ^y	€ 6.997 ^y	€ 7.331 ^y	€ 7.658 ^y	€ 7.982 ^y	€ 8.208 ^y	€ 8.529 ^y
4.00	€ 5.926 ^y	€ 6.259 ^y	€ 6.593 ^y	€ 6.792 ^y	€ 7.231 ^y	€ 7.576 ^y	€ 7.914 ^y	€ 8.248 ^y	€ 8.480 ^y	€ 8.815 ^y
4.50	€ 6.158 ^y	€ 6.505 ^y	€ 6.852 ^y	€ 7.056 ^y	€ 7.513 ^y	€ 7.869 ^y	€ 8.221 ^y	€ 8.570 ^y	€ 8.806 ^y	€ 9.155 ^y
5.00	€ 6.334 ^y	€ 6.695 ^y	€ 7.057 ^y	€ 7.265 ^y	€ 7.748 ^y	€ 8.123 ^y	€ 8.486 ^y	€ 8.850 ^y	€ 9.078 ^y	€ 9.441 ^y
5.50	€ 6.565 ^y	€ 6.941 ^y	€ 7.316 ^y	€ 7.529 ^y	€ 8.027 ^y	€ 8.417 ^y	€ 8.794 ^y	€ 9.172 ^y	€ 9.404 ^y	€ 9.781 ^y

I PREZZI INCLUDONO IL MOTORE - DRIVE BOX (SAFETY BOX)

I PREZZI INCLUDONO IL MOTORE (SAFETY BOX)

I PREZZI NON INCLUDONO INSTALLAZIONE E IVA.

I PREZZI NON INCLUDONO INSTALLAZIONE E IVA

PER LA SCELTA DELL'ACCIAIO INOX, MAGGIORAZIONE DEL 5% SUL PREZZO DI LISTINO

PER PARTI INOX AGGIUNTA DEL 5% SUL PREZZO DI LISTINO

MOTORE MOTORE

85/17

BEAUFORT

*7 *8 *9 *10 



VERNICE RAL 8% SUL LISTINO PER SCELTA FUORI DAI 7 STANDARD

VERNICE RAL 8% SUL PREZZO DI LISTINO PER SELEZIONE TRA 7 STANDARD

52 FIORI FINE SHADING

FLOPPER 160

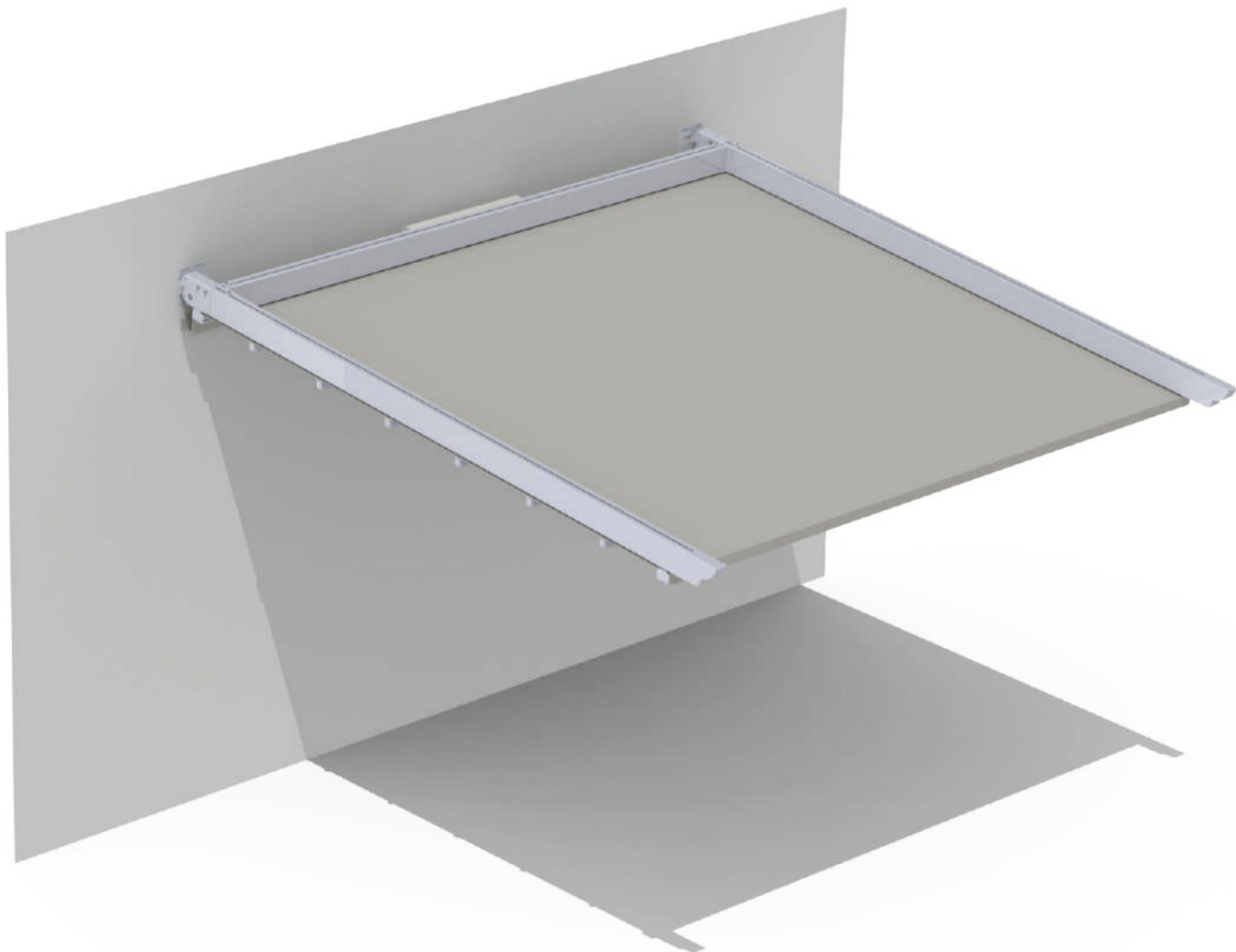

RACCORDI IN METALLO ZINCATO STANDARD
PARTI METALLICHE STANDARD ZINCATE

COLORI STANDARD



MOVIMENTO



LUCENTEZZA



ZABULINO DI ZIMIRELLA



TESSUTI TECNICI



ASSALE / ASSE	SCARICA / PROIEZIONE																
	2.50	3.00	3.50	4.00	4.50	5.00	5.50	6.00	6.50	7.00	7.50	8.00	8.50	9.00	9.50	10.00	
2.50	€3.119 y	€3.291 y	€ 3.425 y € 3.894 y € 3.763 y € 3.932 y				€4.102 y	€4.273 y	€4.530 y €4.696 y €4.711 y €4.86 y	€4.984 y				€5.174 y	€5.293 y	€5.448 y	
3.00	€3.191 y	€3.372 y	€ 3.510 y € 3.889 y € 3.868 y € 4.047 y				€4.227 y	€4.407 y	€4.674 y €4.850 y €4.876 y €5.035 y €5.169 y					€5.373 y	€5.497 y	€5.662 y	
3.50	€3.350 y	€3.541 y	€3.684 y €3.872 y €4.061 y €4.250 y				€4.439 y	€4.629 y	€4.906 y €5.092 y €5.130 y €5.299 y €5.443 y					€5.663 y	€5.791 y	€5.966 y	
4.00	€3.421 y	€3.622 y	€3.769 y €3.967 y €4.166 y €4.365 y				€4.564 y	€4.763 y	€5.050 y €5.245 y €5.295 y €5.473 y €5.628 y					€5.863 y	€5.996 y	€6.180 y	
4.50	€3.580 y	€3.790 y	€3.943 y €4.150 y €4.359 y €4.567 y				€4.776 y	€4.985 y	€ 5.282 y € 5.487 y € 5.549 y € 5.736 y € 5.903 y					€6.153 y	€6.291 y	€6.485 y	
5.00	€3.999 y	€4.274 y	€4.485 y €4.761 y €5.038 y €5.315 y				€5.592 y	€5.957 y	€6.236 y €6.509 y €6.548 y €6.796 y €6.993 y					€7.350 y	€7.541 y	€7.797 y	
5.50	€4.070 y	€4.355 y	€4.571 y €4.856 y €5.143 y €5.429 y				€5.716 y	€6.091 y	€6.380 y €6.662 y €6.713 y €6.97 y €7.172 y					€7.552 y	€7.748 y	€8.014 y	
6.00	€4.142 y	€4.436 y	€4.657 y €4.952 y €5.247 y €5.544 y				€5.841 y	€6.225 y	€6.523 y €6.815 y €6.877 y €7.145 y €7.351 y					€7.755 y	€7.955 y	€8.232 y	
6.50	€4.301 y	€4.605 y	€4.830 y €5.135 y €5.441 y €5.747 y				€6.054 y	€6.448 y	€6.756 y €7.057 y €7.132 y €7.409 y €7.620 y					€8.048 y	€8.254 y	€8.540 y	
7.00	€4.372 y	€4.686 y	€4.916 y €5.230 y €5.546 y €5.86 y				€6.265 y	€6.582 y	€6.900 y €7.211 y €7.297 y €7.583 y €7.799 y					€8.252 y	€8.462 y	€8.759 y	
7.50	€4.480 y	€4.808 y	€5.043 y €5.372 y €5.702 y €6.033 y				€6.452 y	€6.784 y	€7.117 y €7.443 y €7.546 y €7.847 y €8.068 y					€8.557 y	€8.772 y	€9.085 y	
8.00	€4.551 y	€4.889 y	€ 5.128 y € 5.468 y € 5.807 y € 6.235 y				€6.576 y	€6.918 y	€7.260 y €7.596 y €7.711 y €8.022 y €8.247 y					€8.762 y	€8.982 y	€9.304 y	
8.50	€4.710 y	€5.058 y	€5.302 y €5.651 y €6.000 y €6.437 y				€6.788 y	€7.140 y	€7.492 y €7.838 y €7.965 y €8.285 y €8.516 y					€9.057 y	€9.282 y	€9.614 y	
9.00	€4.786 y	€5.139 y	€ 5.387 y € 5.746 y € 6.105 y € 6.552 y				€6.912 y	€7.274 y	€7.636 y €7.991 y €8.130 y €8.459 y €8.695 y					€9.262 y	€9.492 y	€9.834 y	
9.50	€5.296 y	€5.716 y	€6.018 y €6.445 y €6.959 y €7.387 y				€7.817 y	€8.247 y	€8.678 y €9.101 y €9.218 y €9.609 y €9.898 y €10.563 y €10.846 y €11.252 y								
10.00	€5.373 y	€5.803 y	€6.110 y €6.540 y €7.064 y €7.502 y				€7.941 y	€8.381 y	€8.822 y €9.254 y €9.383 y €9.783 y €10.077 y €10.770 y €11.058 y €11.474 y								
10.50	€5.450 y	€5.890 y	€6.202 y €6.729 y €7.169 y €7.617 y				€8.066 y	€8.515 y	€8.966 y €9.408 y €9.548 y €9.957 y €10.256 y €10.978 y €11.271 y €11.697 y								
11.00	€5.527 y	€5.977 y	€6.294 y €6.831 y €7.281 y €7.73 y				€8.190 y	€8.649 y	€9.110 y €9.561 y €9.713 y €10.132 y €10.435 y €11.186 y €11.484 y €11.920 y								
11.50	€5.604 y	€6.065 y	€6.386 y €6.933 y €7.394 y €7.854 y				€8.314 y	€8.783 y	€9.254 y €9.715 y €9.877 y €10.306 y €10.614 y €11.394 y €11.697 y €12.144 y								
12.00	€5.682 y	€6.152 y	€6.566 y €7.036 y €7.506 y €7.977 y				€8.447 y	€8.918 y	€9.398 y €9.868 y €10.042 y €10.481 y €10.943 y €11.603 y €11.911 y €12.368 y								
12.50	€5.848 y	€6.328 y	€6.746 y €7.227 y €7.707 y €8.188 y				€8.669 y	€9.149 y	€9.630 y €10.110 y €10.296 y €10.744 y €11.215 y €11.903 y €12.216 y €12.684 y								
13.00	€5.926 y	€6.416 y	€6.839 y €7.330 y €7.821 y €8.311 y				€8.802 y	€9.292 y	€9.783 y €10.274 y €10.461 y €10.918 y €11.397 y €12.112 y €12.431 y €12.909 y								
13.50	€6.498 y	€7.062 y	€7.549 y €8.113 y €8.678 y €9.242 y				€9.806 y €10.370 y €10.935 y €11.499 y €11.664 y €12.199 y €12.691 y €13.400 y €13.772 y €14.312 y										
14.00	€6.571 y	€7.233 y	€7.636 y €8.210 y €8.784 y €9.358 y				€9.932 y €10.506 y €11.080 y €11.654 y €11.830 y €12.375 y €12.873 y €13.598 y €13.974 y €14.524 y										
14.50	€6.680 y	€7.357 y	€7.765 y €8.354 y €8.943 y €9.532 y €10.121 y €10.710 y €11.299 y €11.888 y €12.082 y €12.642 y €13.146 y €13.898 y €14.279 y €14.845 y														
15.00	€6.751 y	€7.437 y	€7.850 y €8.449 y €9.047 y €9.646 y €10.245 y €10.843 y €11.442 y €12.041 y €12.246 y €12.816 y €13.328 y €14.093 y €14.479 y €15.055 y														

I PREZZI INCLUDONO IL MOTORE - DRIVE BOX (SAFETY BOX)

I PREZZI INCLUDONO IL MOTORE (SAFETY BOX)

I PREZZI NON INCLUDONO INSTALLAZIONE E IVA.

I PREZZI NON INCLUDONO INSTALLAZIONE E IVA

PER LA SCELTA DELL'ACCIAIO INOX, MAGGIORAZIONE DEL 4% SUL PREZZO DI LISTINO

PER PARTI INOX AGGIUNTA DEL 4% SUL PREZZO DI LISTINO

MOTORE MOTORE

■ 55/17, 85/17

BEAUFORT

°6 °7 °8 °9 °10



VERNICE RAL 8% SUL LISTINO PER SCELTA FUORI DAI 7 STANDARD

VERNICE RAL 8% SUL PREZZO DI LISTINO PER SELEZIONE TRA 7 STANDARD

FLOPER 160 CON SENO

FLOPER 160 CON GRONDAIA

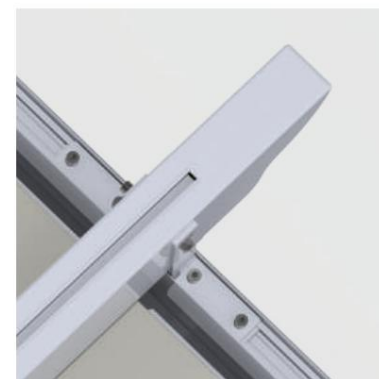
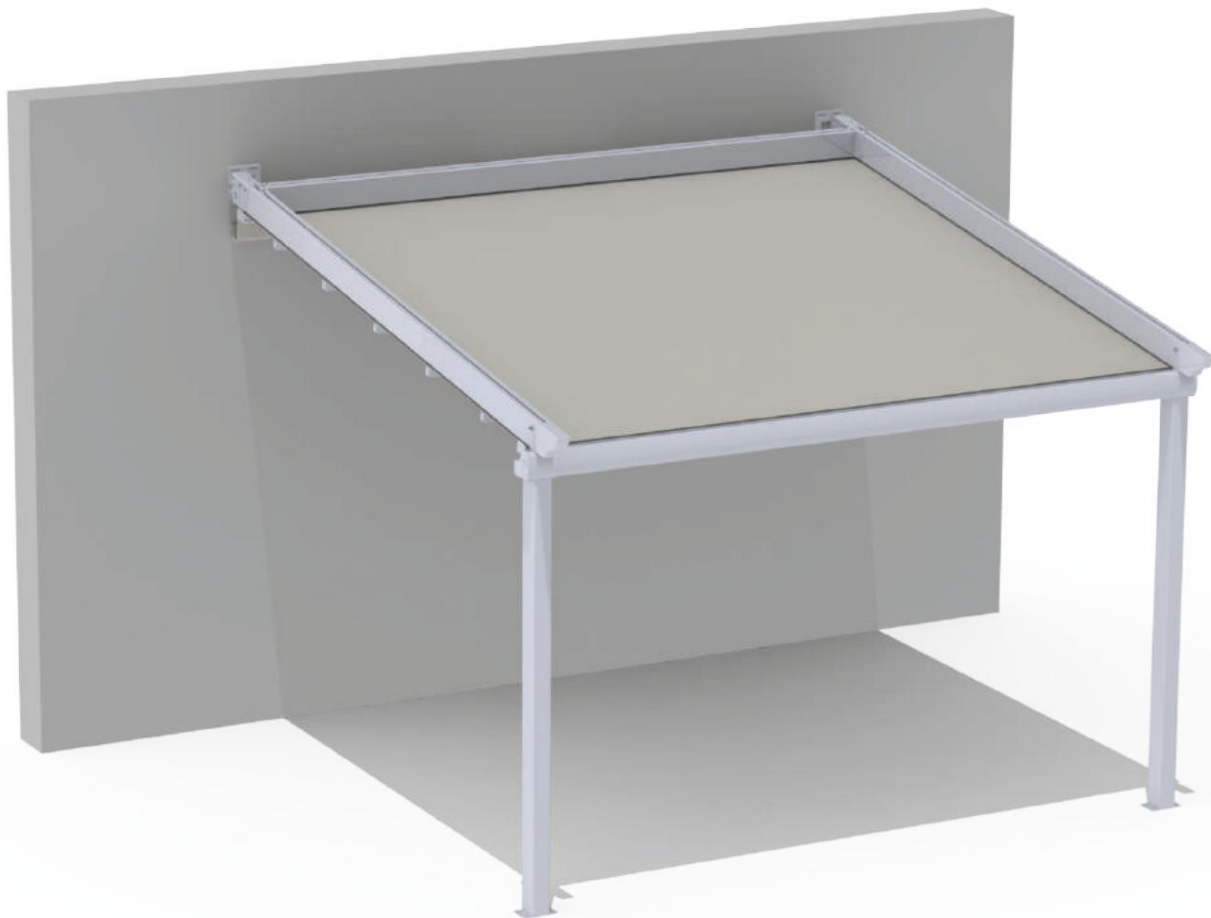

RACCORDI IN METALLO ZINCATO STANDARD
PARTI METALLICHE STANDARD ZINCATE

COLORI STANDARD



GARANZIA
5 ANNI
GARANZIA



MOVIMENTO



Colore RAL 1013

LUCENTEZZA



9010



7040



1019



9005



7021



8014

ZABULINO DI ZIMIRELLA



TESSUTI TECNICI



ASSALE / ASSE	SCARICA / PROIEZIONE																	
	2.50	3.00	3.50	4.00	4.50	5.00	5.50	6.00	6.50	7.00	7.50	8.00	8.50	9.00	9.50	10.00		
2.50	€3.775 y €3.948 y €4.082 y			€4.252 y	€4.422 y €4.593 y €4.764 y €4.935 y €5.194 y					€5.360 y	€5.382 y	€ 5.531 y € 5.656 y € 5.846 y € 5.965 y € 6.120 y						
3.00	€3.878 y €4.061 y €4.200 y			€4.380 y	€4.560 y €4.740 y €4.921 y € 5.101 y €5.370 y					€5.546 y	€5.580 y	€ 5.738 y € 5.874 y € 6.079 y € 6.203 y € 6.367 y						
3.50	€4.070 y €4.262 y €4.407 y			€4.596 y	€4.786 y €4.976 y €5.166 y €5.357 y €5.635 y					€5.821 y	€5.867 y	€ 6.035 y € 6.182 y € 6.402 y € 6.531 y € 6.705 y						
4.00	€4.173 y €4.376 y €4.524 y			€4.723 y	€4.923 y €5.123 y €5.323 y €5.523 y €5.812 y					€6.007 y	€6.065 y	€ 6.243 y € 6.401 y € 6.636 y € 6.770 y € 6.954 y						
4.50	€4.364 y €4.577 y €4.730 y			€4.939 y	€ 5.148 y € 5.358 y € 5.568 y € 5.778 y € 6.076 y					€6.281 y	€6.352 y	€ 6.539 y € 6.710 y € 6.960 y € 7.099 y € 7.293 y						
5.00	€5.014 y €5.291 y €5.504 y			€5.781 y	€6.059 y €6.337 y €6.616 y €6.983 y €7.263 y					€7.536 y	€7.586 y	€ 7.834 y € 8.032 y € 8.394 y € 8.586 y € 8.843 y						
5.50	€ 5.118 y € 5.404 y € 5.621 y			€5.908 y	€6.196 y €6.484 y €6.773 y €7.149 y €7.439 y					€7.722 y	€7.784 y	€ 8.042 y € 8.245 y € 8.631 y € 8.827 y € 9.094 y						
6.00	€ 5.222 y € 5.517 y € 5.739 y			€6.036 y	€6.333 y €6.631 y €6.930 y €7.316 y €7.616 y					€7.908 y	€7.982 y	€ 8.249 y € 8.487 y € 8.868 y € 9.069 y € 9.346 y						
6.50	€ 5.413 y € 5.719 y € 5.946 y			€6.252 y	€6.559 y €6.867 y €7.175 y €7.577 y €7.881 y					€8.183 y	€8.270 y	€ 8.546 y € 8.759 y € 9.196 y € 9.402 y € 9.689 y						
7.00	€5.517 y €5.832 y €6.063 y			€6.380 y	€6.696 y €7.014 y €7.419 y €7.738 y €8.057 y					€8.369 y	€8.467 y	€ 8.753 y € 8.971 y € 9.434 y € 9.645 y € 9.942 y						
7.50	€ 5.657 y € 5.987 y € 6.223 y			€6.554 y	€6.886 y €7.218 y €7.638 y €7.972 y €8.307 y					€8.633 y	€8.750 y	€ 9.050 y € 9.273 y € 9.774 y € 9.990 y € 10.303 y						
8.00	€5.760 y €6.100 y €6.341 y			€6.682 y	€7.023 y €7.492 y €7.795 y €8.139 y €8.483 y					€8.819 y	€8.948 y	€ 9.258 y € 9.485 y € 10.013 y € 10.234 y € 10.557 y						
8.50	€5.951 y €6.301 y €6.546 y			€6.897 y	€7.248 y €7.687 y €8.040 y €8.394 y €8.748 y					€9.094 y	€9.235 y	€ 9.554 y € 9.786 y € 10.343 y € 10.569 y € 10.901 y						
9.00	€6.061 y €6.414 y €6.664 y			€7.025 y	€7.386 y €7.834 y €8.197 y €8.560 y €8.924 y					€9.280 y	€9.432 y	€ 9.762 y € 9.999 y € 10.583 y € 10.813 y € 11.157 y						
9.50	€6.803 y €7.223 y €7.526 y			€7.955 y	€8.471 y €8.902 y €9.334 y €9.766 y €10.199 y €10.623 y €10.756 y €11.146 y €11.437 y €12.124 y €12.408 y €12.814 y													
10.00	€6.913 y €7.344 y €7.651 y			€8.082 y	€8.609 y €9.049 y €9.490 y €9.933 y €10.376 y €10.809 y €10.954 y €11.353 y €11.649 y €12.366 y €12.655 y €13.072 y													
10.50	€7.024 y €7.465 y €7.777 y			€8.305 y	€8.746 y €9.196 y €9.647 y €10.099 y €10.552 y €10.995 y €11.152 y €11.561 y €11.862 y €12.609 y €12.903 y €13.330 y													
11.00	€7.136 y €7.587 y €7.904 y			€8.441 y	€8.892 y €9.343 y €9.804 y €10.266 y €10.729 y €11.181 y €11.350 y €11.768 y €12.074 y €12.852 y €13.151 y €13.588 y													
11.50	€7.247 y €7.708 y €8.030 y			€8.578 y	€9.039 y €9.500 y €9.961 y €10.433 y €10.905 y €11.367 y €11.548 y €11.976 y €12.286 y €13.096 y €13.400 y €13.847 y													
12.00	€7.359 y €7.830 y €8.244 y			€8.715 y	€9.186 y €9.657 y €10.128 y €10.599 y €11.082 y €11.553 y €11.746 y €12.183 y €12.672 y €13.340 y €13.649 y €14.107 y													
12.50	€7.559 y €8.040 y €8.459 y			€8.940 y	€9.421 y €9.903 y €10.384 y €10.865 y €11.346 y €11.828 y €12.033 y €12.480 y €12.977 y €13.676 y €13.990 y €14.458 y													
13.00	€7.671 y €8.162 y €8.586 y			€9.078 y	€9.569 y €10.060 y €10.552 y €11.043 y €11.534 y €12.026 y €12.231 y €12.687 y €13.192 y €13.921 y €14.240 y €14.718 y													
13.50	€8.496 y €9.061 y €9.548 y € 10.113 y € 10.678 y €11.243 y € 11.809 y € 12.374 y €12.939 y €13.504 y € 13.689 y € 14.225 y € 14.737 y € 15.447 y €15.819 y €16.361 y																	
14.00	€8.601 y €9.264 y €9.668 y € 10.243 y € 10.818 y €11.393 y € 11.967 y € 12.542 y €13.117 y €13.692 y €13.889 y € 14.434 y € 14.953 y € 15.678 y €16.055 y €16.607 y																	
14.50	€8.744 y €9.422 y €9.830 y € 10.420 y € 11.010 y € 11.600 y € 12.190 y € 12.780 y € 13.369 y €13.959 y €14.174 y € 14.735 y € 15.281 y € 16.013 y € 16.394 y €16.961 y																	
15.00	€8.847 y €9.534 y €9.948 y € 10.547 y € 11.147 y € 11.746 y € 12.346 y € 12.946 y €13.545 y € 14.145 y €14.371 y € 14.942 y € 15.475 y € 16.242 y € 16.628 y €17.204 y																	

I PREZZI INCLUDONO IL MOTORE - DRIVE BOX (SAFETY BOX)

I PREZZI INCLUDONO IL MOTORE (SAFETY BOX)

I PREZZI NON INCLUDONO INSTALLAZIONE E IVA.

I PREZZI NON INCLUDONO INSTALLAZIONE E IVA

PER LA SCELTA DELL'ACCIAIO INOX, MAGGIORAZIONE DEL 5% SUL PREZZO DI LISTINO

PER PARTI INOX AGGIUNTA DEL 5% SUL PREZZO DI LISTINO

MOTORE MOTORE

■ 55/17, 85/17

BEAUFORT

°6 °7 °8 °9 °10 



VERNICE RAL 8% SUL

LISTINO PER SCELTA FUORI DAI

7 STANDARD

VERNICE RAL 8% SUL PREZZO DI LISTINO PER

SELEZIONE TRA 7 STANDARD

FLOPER 160 CON RINFORZO E TRAVE

FLOPER 160 CON GRONDAIA E SUPPORTO TRAVE LATERALE

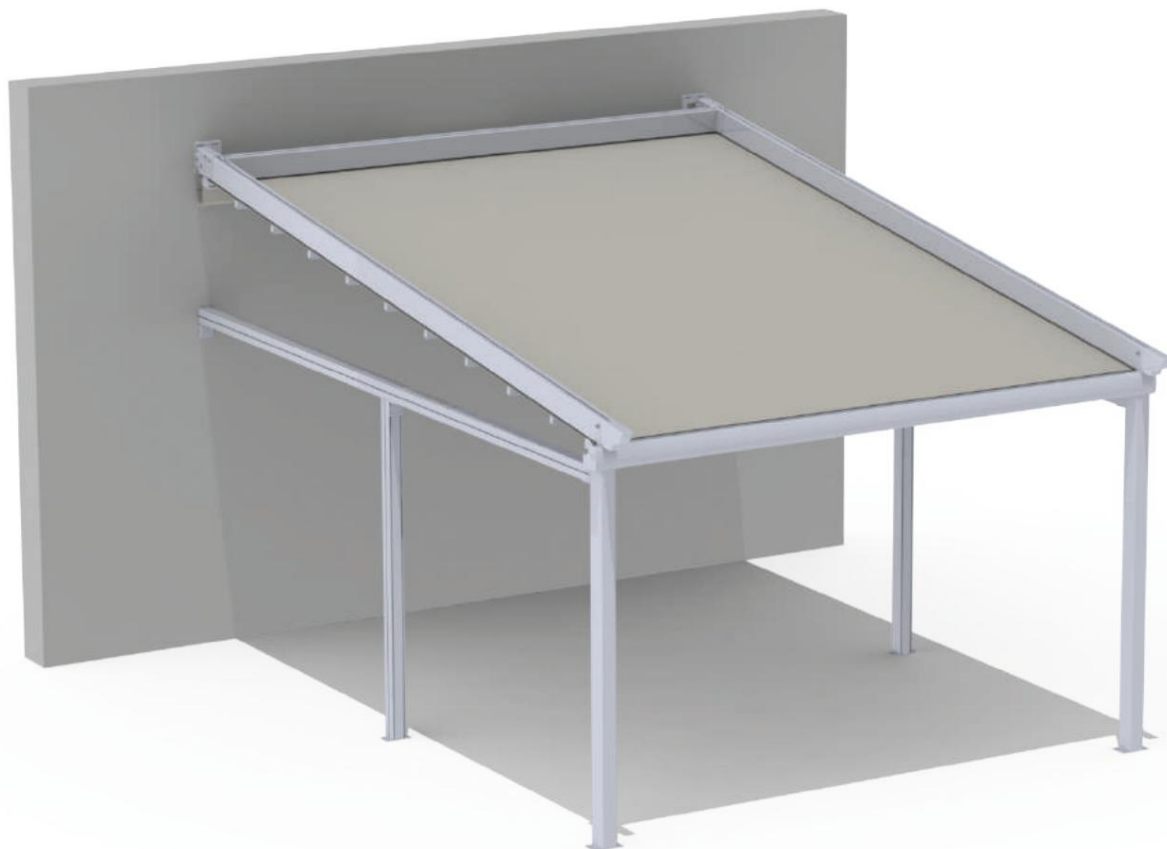

PER UN PIAZZOLINO SUPERIORE A 5 M, VENGONO INSTALLATE LATERALMENTE UNA TRAVE E UNA COLONNA 100X100.
PER SPORGENZE SUPERIORI A 5 M VIENE POSIZIONATA UNA COLONNA SULLA TRAVE LATERALE 100X100.

RACCORDI IN METALLO ZINCATO STANDARD
PARTI METALLICHE STANDARD ZINCATE

COLORI STANDARD



MOVIMENTO



LUCENTEZZA



ZABULINO DI ZIMIRELLA



TESSUTI TECNICI



ASSALE / ASSE	SCARICA / PROIEZIONE															
	2.50	3.00	3.50	4.00	4.50	5.00	5.50	6.00	6.50	7.00	7.50	8.00	8.50	9.00	9.50	10.00
2.50	€4.157 y	€4.374 y	€4.553 y €4.767 y	€4.982 y €5.197 y			€5.689 y	€5.905 y	€6.210 y €6.420 y	€6.497 y €6.690 y	€6.860 y			€7.095 y	€7.259 y	€7.458 y
3.00	€4.261 y	€4.488 y	€4.672 y €4.896 y	€5.120 y €5.345 y			€5.847 y	€6.073 y	€6.387 y €6.608 y	€6.896 y €6.899 y	€7.081 y			€7.331 y	€7.499 y	€7.709 y
3.50	€4.453 y	€4.691 y	€4.879 y €5.113 y	€5.347 y €5.582 y			€6.094 y	€6.330 y	€6.654 y €6.884 y	€6.986 y €7.197 y	€7.392 y			€7.657 y	€7.831 y	€8.050 y
4.00	€4.557 y	€4.805 y	€4.998 y €5.241 y	€5.486 y €5.730 y			€6.251 y	€6.497 y	€6.831 y €7.071 y	€7.185 y €7.406 y	€7.613 y			€7.894 y	€8.072 y	€8.301 y
4.50	€4.750 y	€5.007 y	€5.205 y €5.458 y	€5.712 y €5.967 y			€6.498 y	€6.754 y	€7.098 y €7.347 y	€7.473 y €7.704 y	€7.925 y			€8.221 y	€8.404 y	€8.644 y
5.00	€5.404 y	€5.725 y	€5.983 y €6.305 y	€6.628 y €6.952 y			€7.552 y	€7.965 y	€8.291 y €8.609 y	€8.715 y €9.007 y	€9.251 y			€9.665 y	€9.902 y €10.204 y	
5.50	€5.508 y	€5.839 y	€6.101 y €6.434 y	€6.766 y €7.100 y			€7.710 y	€8.133 y	€8.469 y €8.796 y	€8.914 y €9.216 y	€9.465 y			€9.904 y €10.146 y	€10.458 y	
6.00	€5.613 y	€5.953 y	€6.220 y €6.562 y	€6.905 y €7.248 y			€7.868 y	€8.301 y	€8.646 y €8.984 y	€9.113 y €9.424 y	€9.678 y €10.144 y	€10.390 y €10.713 y				
6.50	€5.805 y	€6.156 y	€6.427 y €6.779 y	€7.132 y €7.485 y			€8.115 y	€8.557 y	€8.913 y €9.260 y	€9.402 y €9.723 y	€9.982 y €10.475 y	€10.726 y €11.059 y				
7.00	€5.910 y	€6.270 y	€6.546 y €6.908 y	€7.270 y €7.633 y			€8.360 y	€8.725 y	€9.090 y €9.447 y	€9.601 y €9.932 y	€10.195 y €10.716 y	€10.972 y €11.315 y				
7.50	€6.050 y	€6.425 y	€6.706 y €7.083 y	€7.460 y €7.838 y			€8.581 y	€8.961 y	€9.342 y €9.713 y	€9.886 y €10.231 y	€10.499 y €11.059 y	€11.320 y €11.679 y				
8.00	€6.154 y	€6.539 y	€6.825 y €7.211 y	€7.599 y €8.074 y			€8.739 y	€9.128 y	€9.519 y €9.900 y	€10.085 y €10.439 y	€10.713 y €11.301 y	€11.567 y €11.936 y				
8.50	€6.347 y	€6.742 y	€7.032 y €7.428 y	€7.825 y €8.310 y			€8.985 y	€9.385 y	€9.785 y €10.176 y	€10.373 y €10.737 y	€11.016 y €11.634 y	€11.905 y €12.284 y				
9.00	€6.458 y	€6.855 y	€7.151 y €7.577 y	€7.963 y €8.458 y			€9.143 y	€9.552 y	€9.963 y €10.363 y	€10.572 y €10.946 y	€11.229 y €11.877 y	€12.153 y €12.542 y				
9.50	€7.204 y	€7.670 y	€8.017 y €8.492 y	€9.055 y €9.532 y	€10.286 y €10.765 y	€11.245 y €11.715 y	€11.904 y €12.339 y	€12.676 y €13.428 y	€13.753 y €14.211 y							
10.00	€7.315 y	€7.792 y	€8.144 y €8.621 y	€9.194 y €9.680 y	€10.444 y €10.933 y	€11.423 y €11.902 y	€12.103 y €12.547 y	€12.890 y €13.673 y	€14.008 y €14.471 y							
10.50	€7.428 y	€7.914 y	€8.271 y €8.845 y	€9.332 y €9.828 y	€10.602 y €11.101 y	€11.601 y €12.089 y	€12.302 y €12.756 y	€13.104 y €13.919 y	€14.259 y €14.733 y							
11.00	€7.540 y	€8.037 y	€8.399 y €8.983 y	€9.480 y €9.976 y	€10.760 y €11.268 y	€11.778 y €12.276 y	€12.501 y €12.965 y	€13.317 y €14.164 y	€14.510 y €14.994 y							
11.50	€7.652 y	€8.159 y	€8.526 y €9.121 y	€9.628 y €10.135 y	€10.918 y €11.436 y	€11.956 y €12.463 y	€12.700 y €13.173 y	€13.530 y €14.411 y	€14.761 y €15.255 y							
12.00	€7.765 y	€8.282 y	€8.742 y €9.259 y	€9.776 y €10.293 y	€11.087 y €11.604 y	€12.133 y €12.651 y	€12.900 y €13.382 y	€13.935 y €14.658 y	€15.013 y €15.518 y							
12.50	€7.967 y	€8.494 y	€8.959 y €9.486 y	€10.013 y €10.541 y	€11.345 y €11.872 y	€12.399 y €12.927 y	€13.188 y €13.680 y	€14.242 y €14.996 y	€15.357 y €15.872 y							
13.00	€8.080 y	€8.618 y	€9.087 y €9.625 y	€10.162 y €10.700 y	€11.514 y €12.052 y	€12.590 y €13.127 y	€13.387 y €13.889 y	€14.458 y €15.244 y	€15.609 y €16.135 y							
13.50	€8.913 y	€9.525 y €10.059 y	€10.672 y €11.284 y	€11.896 y €12.788 y	€13.400 y €14.012 y	€14.624 y €14.865 y	€15.448 y €16.019 y	€16.778 y €17.197 y	€17.786 y							
14.00	€9.019 y	€9.730 y €10.180 y	€10.802 y €11.424 y	€12.046 y €12.948 y	€13.570 y €14.192 y	€14.814 y €15.066 y	€15.659 y €16.237 y	€17.011 y €17.435 y	€18.034 y							
14.50	€9.163 y	€9.888 y €10.343 y	€10.980 y €11.617 y	€12.254 y €13.171 y	€13.808 y €14.446 y	€15.063 y €15.353 y	€15.962 y €16.547 y	€17.347 y €17.776 y	€18.390 y							
15.00	€9.266 y €10.002 y	€10.461 y €11.108 y	€11.755 y €12.402 y	€13.329 y €13.976 y	€14.622 y €15.269 y	€15.551 y €16.170 y	€16.762 y €17.577 y	€18.011 y €18.635 y								

I PREZZI INCLUDONO IL MOTORE - DRIVE BOX (SAFETY BOX)

I PREZZI INCLUDONO IL MOTORE (SAFETY BOX)

I PREZZI NON INCLUDONO INSTALLAZIONE E IVA.

I PREZZI NON INCLUDONO INSTALLAZIONE E IVA

PER LA SCELTA DELL'ACCIAIO INOX, MAGGIORAZIONE DEL 6% SUL PREZZO DI LISTINO

PER PARTI INOX AGGIUNTA DEL 6% SUL PREZZO DI LISTINO

MOTORE MOTORE

■ 55/17, 85/17

BEAUFORT

°6 °7 °8 °9 °10



VERNICE RAL 8% SUL

LISTINO PER SCELTA FUORI DAI

7 STANDARD

VERNICE RAL 8% SUL PREZZO DI LISTINO PER

SELEZIONE TRA 7 STANDARD

58 FIORI FINE SHADING

FLOPER 160 CURVA

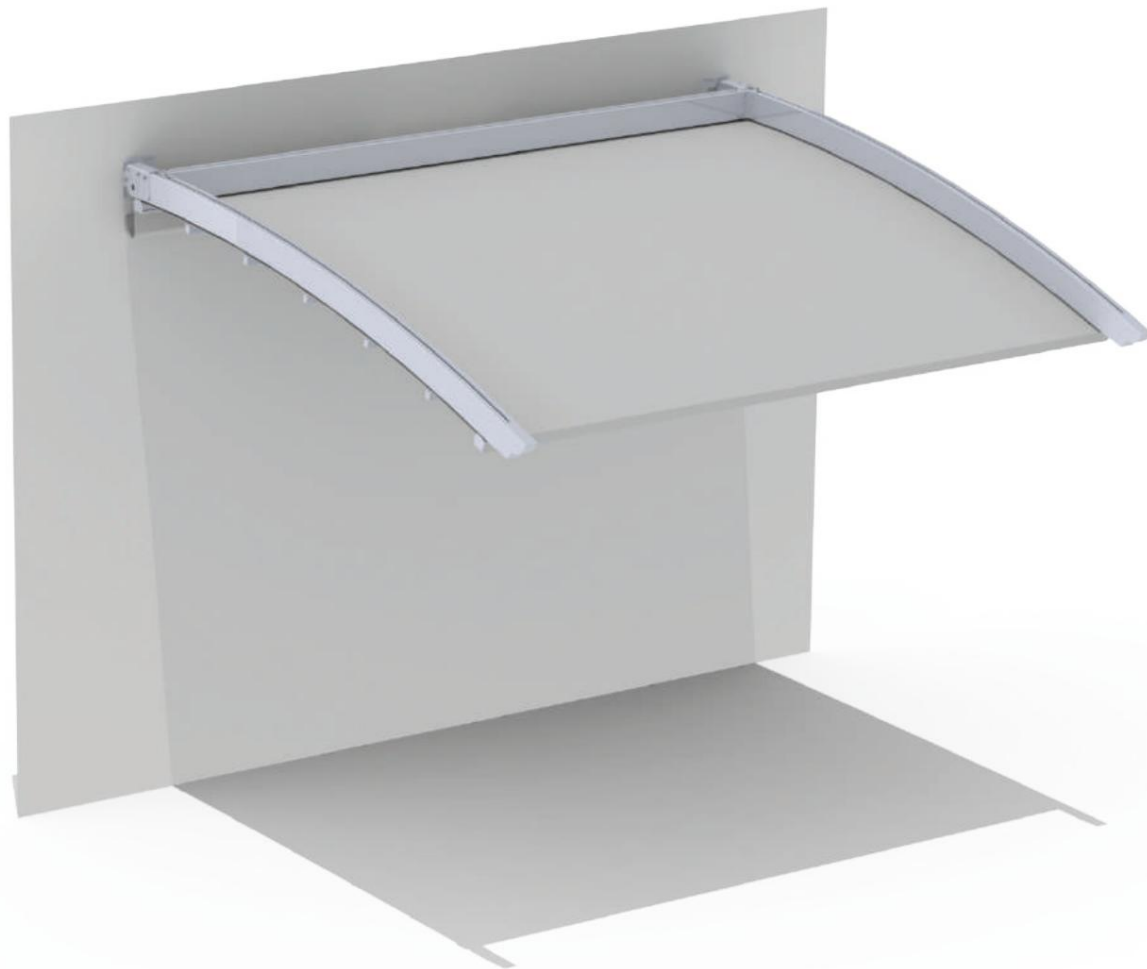

RACCORDI IN METALLO ZINCATO STANDARD
PARTI METALLICHE STANDARD ZINCATE



MOVIMENTO

COLORI STANDARD

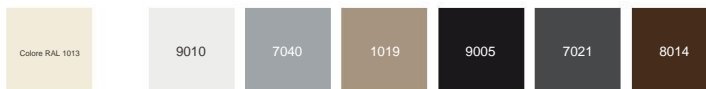

LUCENTEZZA

ZABULINO DI ZIMIRELLA

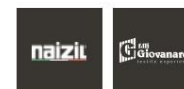

TESSUTI TECNICI



ASSALE / ASSE	SCARICA / PROIEZIONE															
	2.50	3.00	3.50	4.00	4.50	5.00	5.50	6.00	6.50	7.00	7.50	8.00	8.50	9.00	9.50	10.00
2.50	€3.782 y €4.042 y €4.266 y			€4.526 y	€4.786 y €5.046 y €5.307 y €5.568 y €5.917 y					€6.194 y	€6.240 y	€6.492 y €6.722 y €7.073 y €7.321 y €7.608 y				
3.00	€3.855 y €4.124 y €4.353 y			€4.623 y	€4.893 y €5.163 y €5.434 y €5.704 y €6.064 y					€6.352 y	€6.408 y	€6.669 y €6.905 y €7.277 y €7.533 y €7.833 y				
3.50	€4.017 y €4.296 y €4.530 y			€4.809 y	€5.089 y €5.370 y €5.650 y €5.931 y €6.300 y					€6.600 y	€6.665 y	€6.937 y €7.180 y €7.573 y €7.838 y €8.151 y				
4.00	€4.089 y €4.378 y €4.617 y			€4.907 y	€5.196 y €5.487 y €5.777 y €6.068 y €6.447 y					€6.758 y	€6.832 y	€7.115 y €7.364 y €7.779 y €8.051 y €8.378 y				
4.50	€4.251 y €4.550 y €4.793 y			€5.093 y	€5.393 y €5.693 y €5.993 y €6.294 y €6.684 y					€7.006 y	€7.090 y	€7.383 y €7.639 y €8.076 y €8.356 y €8.698 y				
5.00	€4.946 y €5.398 y €5.707 y			€6.120 y	€6.535 y €6.950 y €7.365 y €7.869 y €8.285 y					€8.729 y	€8.821 y	€9.224 y €9.587 y €10.170 y €10.566 y €11.034 y				
5.50	€5.018 y €5.441 y €5.794 y			€6.218 y	€6.642 y €7.067 y €7.492 y €8.006 y €8.433 y					€8.888 y	€8.989 y	€9.403 y €9.772 y €10.379 y €10.784 y €11.266 y				
6.00	€5.091 y €5.523 y €5.881 y			€6.315 y	€6.749 y €7.184 y €7.619 y €8.143 y €8.580 y					€9.047 y	€9.158 y	€9.582 y €9.988 y €10.588 y €11.002 y €11.498 y				
6.50	€5.253 y €5.695 y €6.058 y			€6.502 y	€6.946 y €7.391 y €7.836 y €8.371 y €8.817 y					€9.297 y	€9.416 y	€9.852 y €10.235 y €10.889 y €11.312 y €11.825 y				
7.00	€5.325 y €5.778 y €6.145 y			€6.599 y	€7.053 y €7.508 y €8.052 y €8.596 y €8.965 y					€9.457 y	€9.585 y €10.031 y €10.422 y €10.998 y €11.531 y €12.058 y					
7.50	€5.434 y €5.902 y €6.275 y			€6.743 y	€7.213 y €7.683 y €8.243 y €8.714 y €9.187 y					€9.696 y	€9.839 y €10.301 y €10.699 y €11.142 y €11.855 y €12.403 y					
8.00	€5.507 y €5.984 y €6.362 y			€6.841 y	€7.320 y €7.809 y €8.370 y €8.852 y €9.335 y					€9.856 y €10.008 y €10.480 y €10.886 y €11.622 y €12.075 y €12.638 y						
8.50	€5.668 y €6.166 y €6.538 y			€7.027 y	€7.517 y €8.006 y €8.587 y €9.079 y €9.572 y €10.106 y €10.266 y €10.750 y €11.163 y €11.925 y €12.388 y €12.967 y											
9.00	€5.741 y €6.238 y €6.626 y			€7.124 y	€7.624 y €8.213 y €8.714 y €9.217 y €9.720 y €10.266 y €10.436 y €10.930 y €11.350 y €12.136 y €12.609 y €13.204 y											
9.50	€6.525 y €7.137 y €7.629 y			€8.243 y	€8.945 y €9.561 y €10.178 y €10.796 y €11.415 y €12.085 y €12.263 y €12.869 y €13.399 y €14.345 y €14.941 y €15.671 y											
10.00	€6.597 y €7.219 y €7.716 y			€8.340 y	€9.053 y €9.679 y €10.306 y €10.934 y €11.563 y €12.246 y €12.432 y €13.049 y €13.588 y €14.560 y €15.166 y €15.912 y											
10.50	€6.670 y €7.302 y €7.804 y			€8.526 y	€9.160 y €9.797 y €10.434 y €11.072 y €11.711 y €12.407 y €12.603 y €13.230 y €13.776 y €14.774 y €15.391 y €16.154 y											
11.00	€6.743 y €7.384 y €7.891 y			€8.623 y	€9.268 y €9.914 y €10.562 y €11.210 y €11.860 y €12.568 y €12.772 y €13.411 y €13.965 y €14.989 y €15.617 y €16.396 y											
11.50	€6.815 y €7.467 y €7.979 y			€8.720 y	€9.376 y €10.032 y €10.689 y €11.348 y €12.008 y €12.729 y €12.943 y €13.592 y €14.154 y €15.204 y €15.843 y €16.639 y											
12.00	€6.888 y €7.549 y €8.154 y			€8.818 y	€9.483 y €10.150 y €10.818 y €11.487 y €12.157 y €12.891 y €13.113 y €13.774 y €14.344 y €15.420 y €16.070 y €16.883 y											
12.50	€7.050 y €7.721 y €8.331 y			€9.005 y	€9.680 y €10.357 y €11.035 y €11.714 y €12.395 y €13.142 y €13.373 y €14.045 y €14.624 y €15.729 y €16.390 y €17.221 y											
13.00	€7.122 y €7.804 y €8.418 y			€9.102 y	€9.788 y €10.475 y €11.163 y €11.853 y €12.544 y €13.304 y €13.544 y €14.226 y €14.813 y €15.945 y €16.618 y €17.466 y											
13.50	€8.072 y €8.875 y €9.600 y €10.403 y €11.206 y €12.010 y €12.813 y €13.616 y €14.420 y €15.301 y €15.663 y €16.523 y €17.219 y €18.267 y €18.977 y €19.966 y															
14.00	€8.150 y €9.053 y €9.693 y €10.507 y €11.320 y €12.134 y €12.948 y €13.761 y €14.575 y €15.470 y €15.844 y €16.718 y €17.422 y €18.489 y €19.208 y €20.216 y															
14.50	€8.266 y €9.185 y €9.830 y €10.659 y €11.488 y €12.318 y €13.147 y €13.976 y €14.806 y €15.719 y €16.112 y €17.006 y €17.719 y €18.817 y €19.546 y €20.578 y															
15.00	€8.341 y €9.271 y €9.921 y €10.760 y €11.600 y €12.440 y €13.279 y €14.119 y €14.959 y €15.885 y €16.292 y €17.198 y €17.920 y €19.038 y €19.775 y €20.826 y															

I PREZZI INCLUDONO IL MOTORE - DRIVE BOX (SAFETY BOX)

I PREZZI INCLUDONO IL MOTORE (SAFETY BOX)

I PREZZI NON INCLUDONO INSTALLAZIONE E IVA.

I PREZZI NON INCLUDONO INSTALLAZIONE E IVA

PER LA SCELTA DELL'ACCIAIO INOX, MAGGIORAZIONE DEL 3% SUL PREZZO DI LISTINO

PER PARTI INOX AGGIUNTA DEL 3% SUL PREZZO DI LISTINO

MOTORE MOTORE

■ 55/17, 85/17

BEAUFORT

°6 °7 °8 °9 °10



VERNICE RAL 8% SUL LISTINO PER SCELTA FUORI DAI 7 STANDARD

VERNICE RAL 8% SUL PREZZO DI LISTINO PER SELEZIONE TRA 7 STANDARD

60 FIORI FINE SHADING

FLOPER 160 CURVA CON PETTO

FLOPER 160 CURVA CON GRONDA

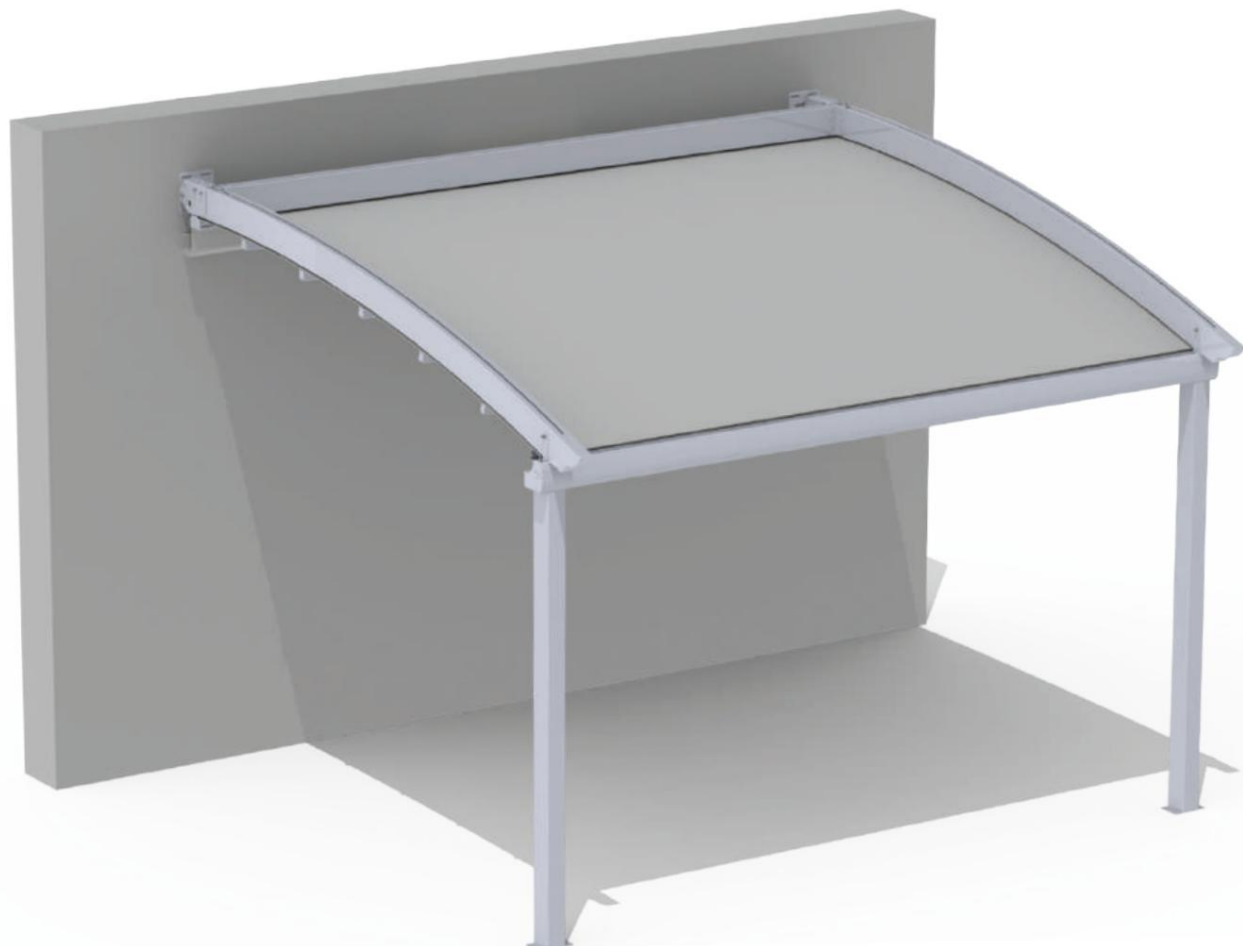

RACCORDI IN METALLO ZINCATO STANDARD
PARTI METALLICHE STANDARD ZINCATE

COLORI STANDARD



MOVIMENTO



LUCENTEZZA



ZABULINO DI ZIMIRELLA

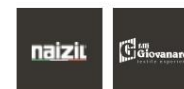

TESSUTI TECNICI



ASSALE / ASSE	SCARICA / PROIEZIONE															
	2.50	3.00	3.50	4.00	4.50	5.00	5.50	6.00	6.50	7.00	7.50	8.00	8.50	9.00	9.50	10.00
2.50	€4.478 y €4.737 y €4.962 y			€5.222 y	€5.483 y €5.744 y €6.005 y €6.266 y €6.616 y					€6.895 y	€6.941 y	€7.193 y €7.425 y €7.783 y €8.035 y €8.325 y				
3.00	€4.583 y €4.833 y €5.082 y			€5.352 y	€5.623 y €5.894 y €6.165 y €6.436 y €6.796 y					€7.086 y	€7.141 y	€7.404 y €7.642 y €8.022 y €8.282 y €8.586 y				
3.50	€4.778 y €5.057 y €5.292 y			€5.572 y	€5.852 y €6.133 y €6.414 y €6.696 y €7.065 y					€7.368 y	€7.432 y	€7.705 y €7.940 y €8.352 y €8.621 y €8.939 y				
4.00	€4.883 y €5.172 y €5.411 y			€5.702 y	€5.992 y €6.283 y €6.574 y €6.865 y €7.245 y					€7.559 y	€7.633 y	€7.916 y €8.168 y €8.592 y €8.869 y €9.201 y				
4.50	€5.077 y €5.376 y €5.620 y			€5.921 y	€6.221 y €6.522 y €6.823 y €7.125 y €7.515 y					€7.840 y	€7.923 y	€8.217 y €8.476 y €8.923 y €9.209 y €9.555 y				
5.00	€6.005 y €6.419 y €6.768 y			€7.182 y	€7.597 y €8.013 y €8.429 y €8.934 y €9.351 y					€9.799 y	€9.890 y €10.295 y €10.661 y €11.258 y €11.661 y €12.136 y					
5.50	€6.110 y €6.534 y €6.888 y			€7.312 y	€7.738 y €8.163 y €8.589 y €9.104 y €9.532 y					€9.992 y €10.092 y €10.507 y €10.881 y €11.502 y €11.914 y €12.403 y						
6.00	€6.215 y €6.649 y €7.008 y			€7.442 y	€7.878 y €8.313 y €8.750 y €9.275 y €9.712 y €10.185 y €10.293 y €10.720 y €11.100 y €11.745 y €12.167 y €12.671 y											
6.50	€6.410 y €6.854 y €7.217 y			€7.662 y	€8.107 y €8.553 y €9.000 y €9.535 y €9.983 y €10.468 y €10.585 y €11.023 y €11.411 y €12.081 y €12.513 y €13.033 y											
7.00	€6.515 y €6.969 y €7.337 y			€7.792 y	€8.248 y €8.704 y €9.248 y €9.706 y €10.164 y €10.561 y €10.787 y €11.235 y €11.631 y €12.326 y €12.767 y €13.303 y											
7.50	€6.657 y €7.126 y €7.500 y			€7.970 y	€8.440 y €8.912 y €9.472 y €9.945 y €10.419 y €10.834 y €11.075 y €11.539 y €11.942 y €12.674 y €13.126 y €13.684 y											
8.00	€6.762 y €7.241 y €7.620 y			€8.100 y	€8.581 y €9.150 y €9.633 y €10.116 y €10.600 y €11.127 y €11.277 y €11.752 y €12.163 y €12.919 y €13.382 y €13.955 y											
8.50	€6.957 y €7.445 y €7.829 y			€8.319 y	€8.810 y €9.390 y €9.883 y €10.376 y €10.870 y €11.410 y €11.569 y €12.055 y €12.474 y €13.257 y €13.730 y €14.321 y											
9.00	€7.062 y €7.561 y €7.949 y			€8.449 y	€8.950 y €9.540 y €10.043 y €10.547 y €11.051 y €11.604 y €11.772 y €12.268 y €12.695 y €13.504 y €13.987 y €14.593 y											
9.50	€8.079 y €8.682 y €9.186 y			€9.801 y €10.506 y €11.123 y €11.742 y €12.361 y €12.982 y €13.660 y €13.835 y €14.444 y €14.983 y €15.946 y €16.565 y €17.308 y												
10.00	€8.184 y €8.808 y €9.306 y			€9.932 y €10.646 y €11.274 y €11.903 y €12.532 y €13.163 y €13.855 y €14.039 y €14.658 y €15.205 y €16.206 y €16.826 y €17.586 y												
10.50	€8.290 y €8.923 y €9.427 y €10.150 y €10.787 y €11.425 y €12.064 y €12.704 y €13.345 y €14.050 y €14.242 y €14.873 y €15.428 y €16.456 y €17.087 y €17.865 y															
11.00	€8.395 y €9.038 y €9.547 y €10.281 y €10.928 y €11.576 y €12.225 y €12.875 y €13.527 y €14.244 y €14.446 y €15.088 y €15.651 y €16.706 y €17.349 y €18.144 y															
11.50	€8.500 y €9.154 y €9.667 y €10.411 y €11.068 y €11.726 y €12.386 y €13.046 y €13.708 y €14.439 y €14.649 y €15.303 y €15.874 y €16.957 y €17.612 y €18.424 y															
12.00	€8.606 y €9.269 y €9.876 y €10.542 y €11.209 y €11.877 y €12.547 y €13.218 y €13.890 y €14.634 y €14.853 y €15.518 y €16.098 y €17.209 y €17.875 y €18.705 y															
12.50	€8.800 y €9.473 y €10.085 y €10.761 y €11.439 y €12.118 y €12.798 y €13.479 y €14.162 y €14.920 y €15.147 y €15.823 y €16.412 y €17.553 y €18.232 y €19.081 y															
13.00	€8.905 y €9.589 y €10.205 y €10.892 y €11.579 y €12.268 y €12.959 y €13.651 y €14.344 y €15.115 y €15.351 y €16.038 y €16.636 y €17.805 y €18.496 y €19.363 y															
13.50	€10.131 y €10.934 y €11.659 y €12.463 y €13.267 y €14.070 y €14.874 y €15.678 y €16.481 y €17.374 y €17.746 y €18.617 y €19.324 y €20.388 y €21.104 y €22.115 y															
14.00	€10.243 y €11.147 y €11.787 y €12.601 y €13.415 y €14.229 y €15.048 y €15.857 y €16.671 y €17.577 y €17.963 y €18.848 y €19.563 y €20.642 y €21.372 y €22.402 y															
14.50	€10.393 y €11.313 y €11.958 y €12.788 y €13.617 y €14.447 y €15.277 y €16.106 y €16.936 y €17.862 y €18.266 y €19.171 y €19.896 y €21.007 y €21.747 y €22.803 y															
15.00	€10.503 y €11.433 y €12.083 y €12.923 y €13.763 y €14.603 y €15.444 y €16.284 y €17.124 y €18.063 y €18.481 y €19.400 y €20.134 y €21.264 y €22.014 y €23.089 y															

I PREZZI INCLUDONO IL MOTORE - DRIVE BOX (SAFETY BOX)

I PREZZI INCLUDONO IL MOTORE (SAFETY BOX)

I PREZZI NON INCLUDONO INSTALLAZIONE E IVA.

I PREZZI NON INCLUDONO INSTALLAZIONE E IVA

PER LA SCELTA DELL'ACCIAIO INOX, MAGGIORAZIONE DEL 4% SUL PREZZO DI LISTINO

PER PARTI INOX AGGIUNTA DEL 4% SUL PREZZO DI LISTINO

MOTORE MOTORE

■ 55/17, 85/17

BEAUFORT

°6 °7 °8 °9 0 



VERNICE RAL 8% SUL LISTINO PER SCELTA FUORI DAI 7 STANDARD

VERNICE RAL 8% SUL PREZZO DI LISTINO PER SELEZIONE TRA 7 STANDARD

FLOPER 160 CURVA CON RINFORZO E TRAVE

FLOPER 160 CURVA CON GRONDAIA E SUPPORTO TRAVE LATERALE



PER UN PIAZZOLINO SUPERIORE A 5 M,
VENGONO
INSTALLATE LATERALMENTE UNA TRAVE E UNA COLONNA 100X100.
PER SPORGENZE SUPERIORI A 5 M, VIENE
POSIZIONATA UNA COLONNA SULLA TRAVE LATERALE
100X100.



RACCORDI IN METALLO ZINCATO STANDARD
PARTI METALLICHE STANDARD ZINCATE

COLORI STANDARD



MOVIMENTO



LUCENTEZZA



ZABULINO DI ZIMIRELLA

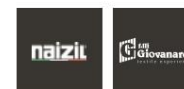

TESSUTI TECNICI



ASSALE / ASSE	SCARICA / PROIEZIONE															
	2.50	3.00	3.50	4.00	4.50	5.00	5.50	6.00	6.50	7.00	7.50	8.00	8.50	9.00	9.50	10.00
2.50	€4.781 y €5.084 y €5.352 y			€5.656 y	€5.960 y €6.264 y €6.847 y €7.152 y €7.545 y					€7.871 y	€7.959 y	€8.256 y €8.534 y €8.948 y €9.249 y €9.590 y				
3.00	€4.886 y €5.199 y €5.472 y			€5.786 y	€6.100 y €6.414 y €7.007 y €7.322 y €7.725 y					€8.062 y	€8.160 y	€8.467 y €8.792 y €9.187 y €9.497 y €9.852 y				
3.50	€5.081 y €5.404 y €5.682 y			€6.005 y	€6.329 y €6.654 y €7.256 y €7.581 y €7.995 y					€8.344 y	€8.450 y	€8.768 y €9.061 y €9.519 y €9.838 y €10.207 y				
4.00	€5.186 y €5.519 y €5.802 y			€6.135 y	€6.469 y €6.803 y €7.416 y €7.751 y €8.175 y					€8.535 y	€8.651 y	€8.980 y €9.279 y €9.759 y €10.067 y €10.471 y				
4.50	€5.380 y €5.723 y €6.010 y			€6.354 y	€6.698 y €7.042 y €7.665 y €8.011 y €8.444 y					€8.817 y	€8.942 y	€9.281 y €9.587 y €10.091 y €10.429 y €10.827 y				
5.00	€6.308 y €6.765 y €7.157 y			€7.615 y	€8.074 y €8.533 y €9.271 y €9.819 y €10.280 y €10.775 y €11.358 y €11.772 y €12.427 y €12.882 y €13.408 y											
5.50	€6.413 y €6.880 y €7.277 y			€7.745 y	€8.214 y €8.683 y €9.431 y €9.990 y €10.461 y €10.968 y €11.511 y €11.571 y €11.992 y €12.671 y €13.135 y €13.677 y											
6.00	€6.518 y €6.995 y €7.397 y			€7.875 y	€8.354 y €8.833 y €9.591 y €10.160 y €10.642 y €11.161 y €11.312 y €11.783 y €12.212 y €12.916 y €13.390 y €13.947 y											
6.50	€6.713 y €7.200 y €7.607 y			€8.095 y	€8.584 y €9.073 y €9.841 y €10.421 y €10.912 y €11.444 y €11.604 y €12.086 y €12.523 y €13.253 y €13.737 y €14.311 y											
7.00	€6.818 y €7.315 y €7.727 y			€8.225 y	€8.724 y €9.223 y €10.090 y €10.591 y €11.093 y €11.638 y €11.807 y €12.299 y €12.744 y €13.498 y €13.993 y €14.582 y											
7.50	€6.960 y €7.472 y €7.889 y			€8.402 y	€8.917 y €9.432 y €10.314 y €10.831 y €11.348 y €11.911 y €12.094 y €12.603 y €13.055 y €13.847 y €14.353 y €14.965 y											
8.00	€7.065 y €7.587 y €8.009 y			€8.532 y	€9.057 y €9.670 y €10.474 y €11.001 y €11.529 y €12.104 y €12.296 y €12.816 y €13.276 y €14.094 y €14.610 y €15.238 y											
8.50	€7.259 y €7.791 y €8.218 y			€8.752 y	€9.286 y €9.910 y €10.724 y €11.262 y €11.800 y €12.388 y €12.589 y €13.120 y €13.588 y €14.433 y €14.960 y €15.605 y											
9.00	€7.364 y €7.906 y €8.338 y			€8.882 y	€9.426 y €10.060 y €10.885 y €11.432 y €11.981 y €12.582 y €12.791 y €13.333 y €13.809 y €14.680 y €15.218 y €15.879 y											
9.50	€8.381 y €9.038 y €9.575 y €10.234 y €10.981 y €11.642 y €12.583 y €13.246 y €13.911 y €14.638 y €14.855 y €15.509 y €16.097 y €17.133 y €17.796 y €18.595 y															
10.00	€8.486 y €9.153 y €9.695 y €10.364 y €11.122 y €11.793 y €12.744 y €13.417 y €14.092 y €14.832 y €15.058 y €15.723 y €16.320 y €17.383 y €18.058 y €18.874 y															
10.50	€8.592 y €9.268 y €9.815 y €10.532 y €11.263 y €11.944 y €12.905 y €13.589 y €14.274 y €15.027 y €15.262 y €15.938 y €16.543 y €17.635 y €18.321 y €19.155 y															
11.00	€8.697 y €9.383 y €9.936 y €10.713 y €11.403 y €12.095 y €13.066 y €13.760 y €14.456 y €15.222 y €15.466 y €16.153 y €16.756 y €17.886 y €18.585 y €19.436 y															
11.50	€8.802 y €9.499 y €10.056 y €10.843 y €11.544 y €12.245 y €13.227 y €13.932 y €14.638 y €15.417 y €15.670 y €16.368 y €16.990 y €18.138 y €18.848 y €19.717 y															
12.00	€8.907 y €9.614 y €10.264 y €10.974 y €11.684 y €12.396 y €13.388 y €14.104 y €14.820 y €15.613 y €15.874 y €16.584 y €17.214 y €18.391 y €19.113 y €20.000 y															
12.50	€9.101 y €9.818 y €10.474 y €11.193 y €11.914 y €12.637 y €13.639 y €14.365 y €15.092 y €15.898 y €16.168 y €16.889 y €17.529 y €18.736 y €19.472 y €20.377 y															
13.00	€9.207 y €9.934 y €10.594 y €11.324 y €12.055 y €12.787 y €13.800 y €14.536 y €15.274 y €16.094 y €16.372 y €17.105 y €17.753 y €18.989 y €19.737 y €20.662 y															
13.50	€10.438 y €11.286 y €12.054 y €12.902 y €13.749 y €14.597 y €15.727 y €16.575 y €17.422 y €18.364 y €18.785 y €19.706 y €20.463 y €21.573 y €22.345 y €23.414 y															
14.00	€10.551 y €11.498 y €12.182 y €13.040 y €13.898 y €14.756 y €15.896 y €16.754 y €17.712 y €18.567 y €19.002 y €19.937 y €20.703 y €21.833 y €22.615 y €23.703 y															
14.50	€10.701 y €11.664 y €12.353 y €13.227 y €14.100 y €14.974 y €16.130 y €17.004 y €17.978 y €18.852 y €19.307 y €20.262 y €21.037 y €22.198 y €22.991 y €24.105 y															
15.00	€10.811 y €11.785 y €12.479 y €13.363 y €14.247 y €15.131 y €16.298 y €17.182 y €18.065 y €19.054 y €19.522 y €20.491 y €21.276 y €22.458 y €23.259 y €24.393 y															

I PREZZI INCLUDONO IL MOTORE - DRIVE BOX (SAFETY BOX)

I PREZZI INCLUDONO IL MOTORE (SAFETY BOX)

I PREZZI NON INCLUDONO INSTALLAZIONE E IVA.

I PREZZI NON INCLUDONO INSTALLAZIONE E IVA

PER LA SCELTA DELL'ACCIAIO INOX, MAGGIORAZIONE DEL 5% SUL PREZZO DI LISTINO

PER PARTI INOX AGGIUNTA DEL 5% SUL PREZZO DI LISTINO

MOTORE MOTORE

■ 55/17, 85/17

BEAUFORT

°6 °7 °8 °9 °10 



VERNICE RAL 8% SUL LISTINO PER SCELTA FUORI DAI 7 STANDARD

VERNICE RAL 8% SUL PREZZO DI LISTINO PER SELEZIONE TRA 7 STANDARD

FLOPER 160 SOLID AUTOPORTANTE

FLOPER 160 SOLID SELF STANDING



RACCORDI IN METALLO ZINCATO STANDARD
PARTI METALLICHE STANDARD ZINCATE

COLORI STANDARD



MOVIMENTO



LUCENTEZZA



ZABULINO DI ZIMIRELLA



TESSUTI TECNICI



ASSALE / ASSE	SCARICA / PROIEZIONE															
	2.50	3.00	3.50	4.00	4.50	5.00	5.50	6.00	6.50	7.00	7.50	8.00	8.50	9.00	9.50	10.00
2.50	€6.120 y €6.475 y €6.866 y			€7.221 y	€7.576 y €7.931 y €8.565 y €8.920 y €9.383 y					€9.738 y	€9.887 y €10.228 y €10.581 y €10.976 y €11.290 y €11.644 y					
3.00	€6.286 y €6.681 y €7.057 y			€7.422 y	€7.786 y €8.151 y €8.795 y €9.160 y €9.633 y					€9.997 y €10.156 y €10.507 y €10.874 y €11.288 y €11.608 y €11.974 y						
3.50	€6.543 y €6.917 y €7.338 y			€7.712 y	€8.087 y €8.462 y €9.115 y €9.490 y €9.972 y €10.347 y €10.515 y €10.876 y €11.258 y €11.690 y €12.017 y €12.396 y											
4.00	€6.709 y €7.094 y €7.529 y			€7.913 y	€8.298 y €8.682 y €9.345 y €9.730 y €10.222 y €10.606 y €10.784 y €11.155 y €11.552 y €11.955 y €12.337 y €12.728 y											
4.50	€6.965 y €7.359 y €7.810 y			€8.204 y	€8.598 y €8.992 y €9.665 y €10.059 y €10.561 y €10.955 y €11.143 y €11.523 y €11.937 y €12.407 y €12.747 y €13.151 y											
5.00	€8.416 y €8.990 y €9.550 y €10.085 y €10.619 y €11.154 y €11.967 y €12.590 y €13.144 y €13.678 y €13.903 y €14.417 y €14.899 y €15.630 y €16.103 y €16.653 y															
5.50	€8.582 y €9.126 y €9.741 y €10.285 y €10.830 y €11.374 y €12.197 y €12.830 y €13.393 y €13.938 y €14.172 y €14.696 y €15.308 y €15.963 y €16.445 y €17.012 y															
6.00	€8.749 y €9.303 y €9.932 y €10.486 y €11.040 y €11.594 y €12.427 y €13.070 y €13.643 y €14.197 y €14.441 y €14.975 y €15.618 y €16.298 y €16.790 y €17.373 y															
6.50	€9.015 y €9.579 y €10.223 y €10.787 y €11.351 y €11.914 y €12.757 y €13.409 y €13.993 y €14.556 y €14.800 y €15.353 y €16.029 y €16.736 y €17.237 y €17.838 y															
7.00	€9.181 y €9.755 y €10.414 y €10.988 y €11.561 y €12.135 y €13.076 y €13.649 y €14.242 y €14.816 y €15.080 y €15.632 y €16.341 y €17.073 y €17.584 y €18.202 y															
7.50	€9.384 y €9.973 y €10.658 y €11.247 y €11.835 y €12.424 y €13.380 y €13.969 y €14.577 y €15.165 y €15.444 y €16.012 y €16.756 y €17.526 y €18.046 y €18.688 y															
8.00	€9.551 y €10.149 y €10.849 y €11.448 y €12.046 y €12.733 y €13.610 y €14.209 y €14.826 y €15.425 y €15.714 y €16.291 y €17.069 y €17.866 y €18.396 y €19.056 y															
8.50	€9.807 y €10.415 y €11.130 y €11.738 y €12.346 y €13.043 y €13.930 y €14.538 y €15.166 y €15.774 y €16.072 y €16.660 y €17.475 y €18.299 y €18.840 y €19.518 y															
9.00	€9.973 y €10.591 y €11.321 y €11.939 y €12.557 y €13.263 y €14.160 y €14.778 y €15.415 y €16.033 y €16.342 y €16.939 y €17.790 y €18.641 y €19.192 y €19.889 y															
9.50	€11.514 y €12.272 y €13.151 y €13.910 y €14.756 y €15.515 y €16.552 y €17.310 y €18.088 y €18.846 y €19.191 y €19.922 y €20.994 y €22.025 y €22.719 y €23.576 y															
10.00	€11.680 y €12.448 y €13.342 y €14.110 y €14.967 y €15.735 y €16.782 y €17.550 y €18.337 y €19.105 y €19.461 y €20.201 y €21.315 y €22.376 y €23.081 y €23.958 y															
10.50	€11.847 y €12.625 y €13.534 y €14.400 y €15.178 y €15.956 y €17.012 y €17.790 y €18.587 y €19.365 y €19.730 y €20.480 y €21.637 y €22.728 y €23.445 y €24.342 y															
11.00	€12.013 y €12.801 y €13.725 y €14.601 y €15.388 y €16.176 y €17.242 y €18.030 y €18.837 y €19.624 y €19.999 y €20.759 y €21.960 y €23.081 y €23.810 y €24.728 y															
11.50	€12.180 y €12.977 y €13.916 y €14.802 y €15.599 y €16.396 y €17.473 y €18.270 y €19.087 y €19.884 y €20.268 y €21.038 y €22.284 y €23.436 y €24.176 y €25.114 y															
12.00	€12.346 y €13.153 y €14.196 y €15.003 y €15.810 y €16.617 y €17.708 y €18.510 y €19.336 y €20.144 y €20.538 y €21.317 y €22.609 y €23.791 y €24.544 y €25.503 y															
12.50	€12.612 y €13.429 y €14.486 y €15.303 y €16.120 y €16.936 y €18.032 y €18.849 y €19.685 y €20.502 y €20.906 y €21.696 y €23.036 y €24.252 y €25.016 y €25.998 y															
13.00	€12.778 y €13.605 y €14.677 y €15.504 y €16.330 y €17.157 y €18.262 y €19.089 y €19.935 y €20.762 y €21.175 y €21.974 y €23.363 y €24.610 y €25.387 y €26.390 y															
13.50	€14.483 y €15.497 y €16.773 y €17.796 y €18.823 y €19.832 y €21.129 y €22.118 y €23.127 y €24.198 y €24.716 y €25.733 y €26.611 y €28.057 y €28.985 y €30.162 y															
14.00	€14.659 y €15.774 y €16.979 y €18.015 y €19.055 y €20.076 y €21.386 y €22.386 y €23.406 y €24.492 y €25.023 y €26.054 y €26.944 y €28.428 y €29.365 y €30.564 y															
14.50	€14.872 y €16.005 y €17.239 y €18.293 y €19.352 y €20.391 y €21.718 y €22.735 y €23.772 y €24.879 y €25.430 y €26.481 y €27.382 y €28.908 y €29.864 y €31.093 y															
15.00	€15.045 y €16.191 y €17.443 y €18.510 y €19.582 y €20.633 y €21.978 y €23.001 y €24.048 y €25.171 y €25.736 y €26.802 y €27.713 y €29.274 y €30.244 y €31.497 y															

I PREZZI INCLUDONO IL MOTORE - DRIVE BOX (SAFETY BOX)

I PREZZI INCLUDONO IL MOTORE (SAFETY BOX)

I PREZZI NON INCLUDONO INSTALLAZIONE E IVA.

I PREZZI NON INCLUDONO INSTALLAZIONE E IVA

PER LA SCELTA DELL'ACCIAIO INOX, MAGGIORAZIONE DEL 5% SUL PREZZO DI LISTINO

PER PARTI INOX AGGIUNTA DEL 5% SUL PREZZO DI LISTINO

MOTORE MOTORE

■ 55/17, 85/17

BEAUFORT

°6 °7 °8 °9 °10 



VERNICE RAL 8% SUL LISTINO PER SCELTA FUORI DAI 7 STANDARD

VERNICE RAL 8% SUL PREZZO DI LISTINO PER SELEZIONE TRA 7 STANDARD

FLOPER 160 SOLID MONTATO A PARETE

FLOPER 160 MONTAGGIO A PARETE SOLIDO

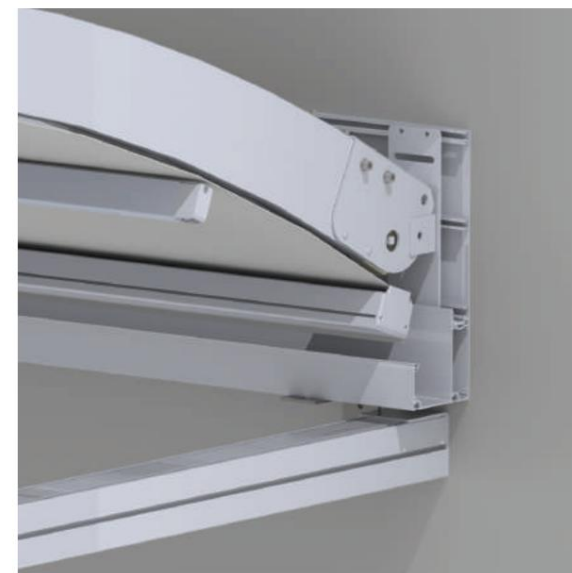
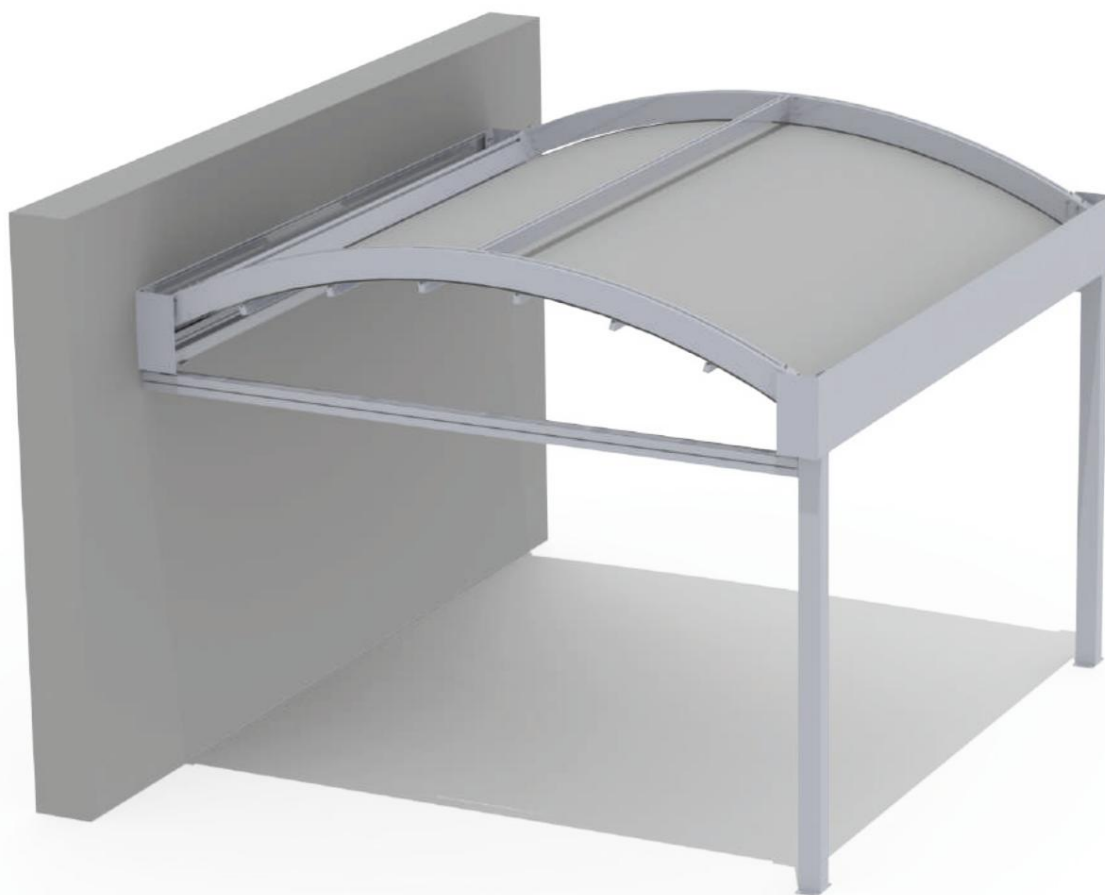

RACCORDI IN METALLO ZINCATO STANDARD
PARTI METALLICHE STANDARD ZINCATE

COLORI STANDARD



MOVIMENTO



LUCENTEZZA



ZABULINO DI ZIMIRELLA



TESSUTI TECNICI



ASSALE / ASSE	SCARICA / PROIEZIONE																
	2.50	3.00	3.50	4.00	4.50	5.00	5.50	6.00	6.50	7.00	7.50	8.00	8.50	9.00	9.50	10.00	
2.50	€5.758 y €6.113 y €6.503 y			€6.858 y	€7.213 y €7.569 y €8.203 y €8.558 y €9.021 y					€9.376 y	€9.524 y	€9.866 y €10.217 y €10.612 y €10.926 y €11.279 y					
3.00	€5.924 y €6.289 y €6.694 y			€7.059 y	€7.424 y €7.789 y €8.433 y €8.798 y €9.270 y					€9.635 y	€9.793 y €10.145 y €10.510 y €10.923 y €11.243 y €11.609 y						
3.50	€6.180 y €6.555 y €6.975 y			€7.350 y	€7.725 y €8.099 y €8.753 y €9.128 y €9.610 y					€9.985 y €10.153 y €10.514 y €10.894 y €11.325 y €11.652 y €12.030 y							
4.00	€6.347 y €6.731 y €7.167 y			€7.551 y	€7.935 y €8.320 y €8.983 y €9.367 y €9.860 y €10.244 y €10.422 y €10.793 y €11.187 y €11.638 y €11.971 y €12.362 y												
4.50	€6.603 y €6.997 y €7.447 y			€7.841 y	€8.235 y €8.630 y €9.303 y €9.687 y €10.199 y €10.593 y €10.781 y €11.161 y €11.572 y €12.041 y €12.381 y €12.784 y												
5.00	€7.872 y €8.407 y €9.007 y			€9.541 y €10.076 y €10.610 y €11.142 y €12.046 y €12.600 y €13.135 y €13.360 y €13.873 y €14.451 y €15.080 y €15.552 y €16.101 y													
5.50	€8.039 y €8.563 y €9.198 y			€9.742 y €10.286 y €10.830 y €11.364 y €12.286 y €12.850 y €13.394 y €13.629 y €14.152 y €14.759 y €15.412 y €15.894 y €16.459 y													
6.00	€8.205 y €8.739 y €9.389 y			€9.943 y €10.497 y €11.051 y €11.584 y €12.526 y €13.100 y €13.654 y €13.898 y €14.431 y €15.068 y €15.746 y €16.236 y €16.819 y													
6.50	€8.471 y €9.035 y €9.680 y €10.243 y €10.807 y €11.371 y €12.214 y €12.866 y €13.449 y €14.013 y €14.267 y €14.810 y €15.478 y €16.182 y €16.682 y €17.282 y																
7.00	€8.638 y €9.211 y €9.871 y €10.444 y €11.018 y €11.591 y €12.532 y €13.106 y €13.699 y €14.272 y €14.536 y €15.089 y €15.789 y €16.519 y €17.028 y €17.645 y																
7.50	€8.841 y €9.430 y €10.115 y €10.703 y €11.292 y €11.881 y €12.837 y €13.425 y €14.033 y €14.622 y €14.901 y €15.469 y €16.203 y €16.970 y €17.490 y €18.130 y																
8.00	€9.007 y €9.606 y €10.306 y €10.904 y €11.502 y €12.189 y €13.067 y €13.665 y €14.283 y €14.881 y €15.170 y €15.748 y €16.516 y €17.309 y €17.838 y €18.496 y																
8.50	€9.263 y €9.872 y €10.586 y €11.194 y €11.803 y €12.499 y €13.386 y €13.995 y €14.622 y €15.230 y €15.529 y €16.116 y €16.921 y €17.741 y €18.281 y €18.956 y																
9.00	€9.430 y €10.048 y €10.777 y €11.395 y €12.013 y €12.720 y €13.617 y €14.235 y €14.872 y €15.490 y €15.798 y €16.395 y €17.235 y €18.082 y €18.632 y €19.326 y																
9.50	€10.789 y €11.547 y €12.427 y €13.185 y €14.032 y €14.790 y €15.827 y €16.585 y €17.363 y €18.121 y €18.467 y €19.197 y €20.253 y €21.279 y €21.970 y €22.824 y																
10.00	€10.955 y €11.723 y €12.618 y €13.386 y €14.242 y €15.010 y €16.057 y €16.825 y €17.613 y €18.381 y €18.736 y €19.476 y €20.573 y €21.628 y €22.331 y €23.204 y																
10.50	€11.122 y €11.900 y €12.809 y €13.675 y €14.453 y €15.231 y €16.288 y €17.065 y €17.863 y €18.640 y €19.005 y €19.755 y €20.894 y €21.979 y €22.693 y €23.587 y																
11.00	€11.288 y €12.076 y €13.000 y €13.876 y €14.664 y €15.451 y €16.518 y €17.305 y €18.112 y €18.900 y €19.274 y €20.034 y €21.216 y €22.330 y €23.056 y €23.970 y																
11.50	€11.455 y €12.252 y €13.191 y €14.077 y €14.874 y €15.672 y €16.748 y €17.545 y €18.362 y €19.159 y €19.544 y €20.313 y €21.538 y €22.688 y €23.421 y €24.355 y																
12.00	€11.621 y €12.429 y €13.471 y €14.278 y €15.085 y €15.892 y €16.978 y €17.785 y €18.612 y €19.419 y €19.813 y €20.593 y €21.862 y €23.038 y €23.787 y €24.742 y																
12.50	€11.887 y €12.704 y €13.761 y €14.578 y €15.395 y €16.212 y €17.308 y €18.124 y €18.961 y €19.778 y €20.181 y €20.971 y €22.289 y €23.497 y €24.258 y €25.235 y																
13.00	€12.054 y €12.880 y €13.952 y €14.779 y €15.605 y €16.432 y €17.538 y €18.364 y €19.210 y €20.037 y €20.451 y €21.250 y €22.614 y €23.858 y €24.627 y €25.625 y																
13.50	€13.567 y €14.578 y €15.853 y €16.873 y €17.898 y €18.907 y €20.208 y €21.192 y €22.201 y €23.268 y €23.784 y €24.799 y €25.674 y €27.109 y €28.033 y €29.204 y																
14.00	€13.742 y €14.855 y €16.058 y €17.091 y €18.129 y €19.150 y €20.458 y €21.458 y €22.478 y €23.561 y €24.090 y €25.119 y €26.005 y €27.474 y €28.411 y €29.604 y																
14.50	€13.955 y €15.086 y €16.317 y €17.369 y €18.426 y €19.464 y €20.790 y €21.807 y €22.843 y €23.947 y €24.496 y €25.545 y €26.442 y €27.957 y €28.908 y €30.131 y																
15.00	€14.128 y €15.271 y €16.520 y €17.585 y €18.655 y €19.705 y €21.044 y €22.071 y €23.119 y €24.238 y €24.801 y €25.864 y €26.772 y €28.321 y €29.286 y €30.532 y																

I PREZZI INCLUDONO IL MOTORE - DRIVE BOX (SAFETY BOX)

I PREZZI INCLUDONO IL MOTORE (SAFETY BOX)

I PREZZI NON INCLUDONO INSTALLAZIONE E IVA.

I PREZZI NON INCLUDONO INSTALLAZIONE E IVA

PER LA SCELTA DELL'ACCIAIO INOX, SOVRAPPREZZO DEL 4,5% SUL LISTINO

PER PARTI INOX AGGIUNTA DEL 4,5% SUL PREZZO DI LISTINO

MOTORE MOTORE

■ 55/17, 85/17

BEAUFORT

°6 °7 °8 °9 10 



VERNICE RAL 8% SUL

LISTINO PER SCELTA FUORI DAI

7 STANDARD

VERNICE RAL 8% SUL PREZZO DI LISTINO PER

SELEZIONE TRA 7 STANDARD

FLOPER 160 SOLIDO

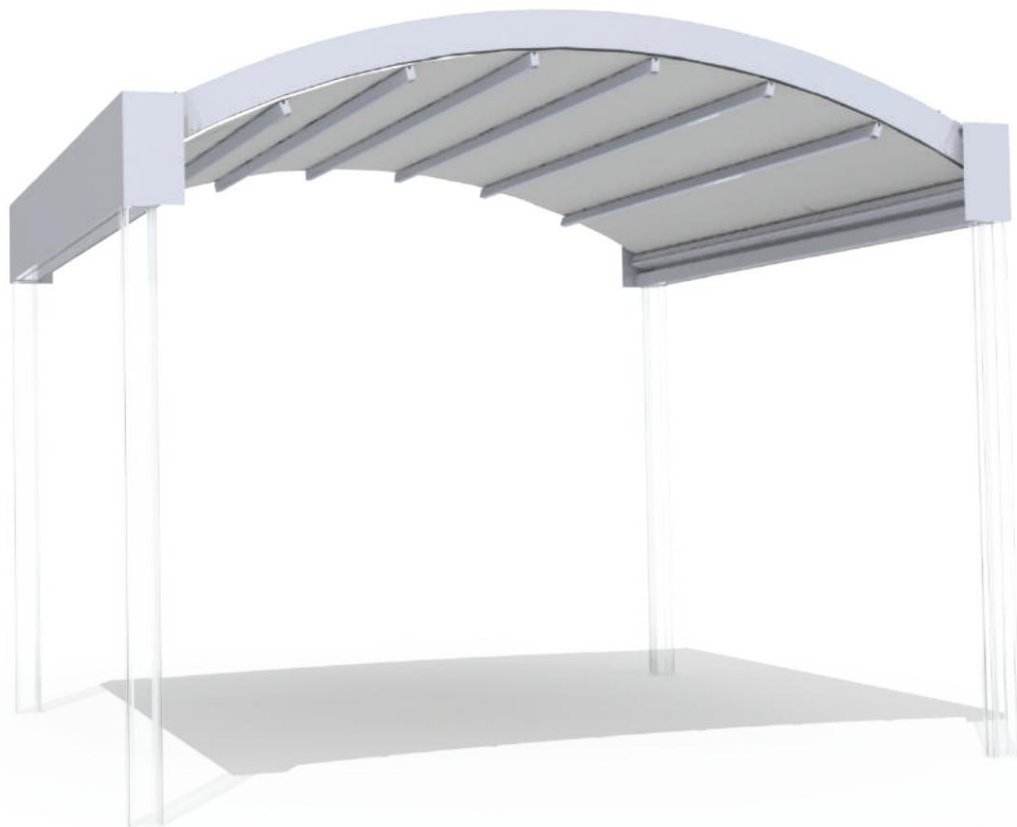

RACCORDI IN METALLO ZINCATO STANDARD
PARTI METALLICHE STANDARD ZINCATE

COLORI STANDARD



MOVIMENTO



LUCENTEZZA



ZABULINO DI ZIMIRELLA



TESSUTI TECNICI



ASSALE / ASSE	SCARICA / PROIEZIONE															
	2.50	3.00	3.50	4.00	4.50	5.00	5.50	6.00	6.50	7.00	7.50	8.00	8.50	9.00	9.50	10.00
2.50	€5.102 y	€5.414 y	€5.761 y €6.072 y	€6.384 y €6.695 y	€7.007 y			€7.318 y	€7.738 y	€8.049 y €8.154 y	€8.452 y €8.753 y			€9.101 y	€9.371 y	€9.679 y
3.00	€5.271 y	€5.592 y	€5.954 y €6.275 y	€6.597 y €6.918 y	€7.239 y			€7.560 y	€7.989 y	€8.311 y €8.425 y	€8.733 y €9.047 y			€9.413 y	€9.689 y €10.009 y	
3.50	€5.530 y	€5.861 y	€6.238 y €6.569 y	€6.900 y €7.231 y	€7.562 y			€7.893 y	€8.331 y	€8.662 y €8.787 y	€9.104 y €9.432 y			€9.817 y €10.098 y	€10.431 y	
4.00	€5.698 y	€6.039 y	€6.431 y €6.772 y	€7.112 y €7.453 y	€7.794 y			€8.135 y	€8.583 y	€8.924 y €9.058 y	€9.385 y €9.727 y	€10.130 y €10.418 y	€10.762 y			
4.50	€5.957 y	€6.307 y	€6.714 y €7.064 y	€7.415 y €7.765 y	€8.116 y			€8.467 y	€8.925 y	€9.275 y €9.420 y	€9.756 y €10.112 y	€10.534 y €10.828 y	€11.185 y			
5.00	€7.077 y	€7.568 y	€8.124 y €8.615 y	€9.106 y €9.597 y	€10.088 y €10.667 y	€11.177 y €11.668 y	€11.849 y	€12.320 y €12.839 y	€13.419 y €13.845 y	€14.347 y						
5.50	€7.246 y	€7.746 y	€8.318 y €8.818 y	€9.319 y €9.820 y	€10.320 y €10.909 y	€11.429 y €11.930 y	€12.121 y	€12.601 y €13.147 y	€13.751 y €14.185 y	€14.703 y						
6.00	€7.414 y	€7.925 y	€8.511 y €9.021 y	€9.532 y €10.042 y	€10.553 y €11.151 y	€11.681 y	€12.192 y €12.392 y	€12.882 y €13.456 y	€14.083 y €14.527 y	€15.061 y						
6.50	€7.683 y	€8.203 y	€8.804 y €9.324 y	€9.844 y €10.365 y	€10.885 y €11.493 y	€12.033 y	€12.553 y €12.763 y	€13.263 y €13.866 y	€14.519 y €14.971 y	€15.522 y						
7.00	€7.851 y	€8.381 y	€8.997 y €9.527 y	€10.057 y €10.587 y	€11.205 y €11.735 y	€12.285 y	€12.815 y €13.035 y	€13.544 y €14.177 y	€14.854 y €15.316 y	€15.883 y						
7.50	€8.057 y	€8.602 y	€9.244 y €9.789 y	€10.334 y €10.879 y	€11.512 y €12.057 y	€12.622 y	€13.167 y €13.402 y	€13.926 y €14.581 y	€15.305 y €15.776 y	€16.366 y						
8.00	€8.226 y	€8.781 y	€9.437 y €9.992 y	€10.546 y €11.190 y	€11.745 y €12.299 y	€12.873 y	€13.428 y €13.673 y	€14.208 y €14.904 y	€15.643 y €16.123 y	€16.730 y						
8.50	€8.484 y	€9.049 y	€9.720 y €10.284 y	€10.849 y €11.502 y	€12.067 y €12.631 y	€13.215 y	€13.780 y €14.034 y	€14.578 y €15.308 y	€16.074 y €16.564 y	€17.189 y						
9.00	€8.653 y	€9.227 y	€9.913 y €10.487 y	€11.062 y €11.725 y	€12.299 y €12.873 y	€13.467 y	€14.041 y €14.306 y	€14.860 y €15.623 y	€16.414 y €16.914 y	€17.556 y						
9.50	€9.863 y €10.578 y	€11.413 y	€12.128 y €12.931 y	€13.646 y €14.361 y	€15.075 y €15.809 y	€16.524 y €16.826 y	€17.513 y	€18.486 y €19.454 y	€20.095 y €20.895 y							
10.00	€10.032 y €10.756 y	€11.607 y	€12.331 y €13.144 y	€13.869 y €14.593 y	€15.317 y €16.061 y	€16.786 y	€17.097 y €17.794 y	€18.805 y €19.802 y	€20.454 y €21.274 y							
10.50	€10.201 y €10.935 y	€11.800 y	€12.623 y €13.357 y	€14.091 y €14.825 y	€15.560 y €16.313 y	€17.047 y	€17.369 y €18.075 y	€19.126 y €20.15 y	€20.814 y €21.553 y							
11.00	€10.369 y €11.113 y	€11.994 y	€12.826 y €13.570 y	€14.314 y €15.058 y	€15.802 y €16.565 y	€17.309 y	€17.640 y €18.357 y	€19.448 y €20.502 y	€21.176 y €22.035 y							
11.50	€10.538 y €11.292 y	€12.187 y	€13.029 y €13.783 y	€14.537 y €15.290 y	€16.044 y €16.817 y	€17.571 y	€17.912 y €18.638 y	€19.770 y €20.854 y	€21.539 y €22.418 y							
12.00	€10.707 y €11.470 y	€12.469 y	€13.232 y €13.996 y	€14.759 y €15.523 y	€16.286 y €17.069 y	€17.833 y	€18.183 y €18.919 y	€20.094 y €21.207 y	€21.904 y €22.802 y							
12.50	€10.975 y €11.748 y	€12.762 y	€13.535 y €14.308 y	€15.081 y €15.855 y	€16.628 y €17.420 y	€18.194 y	€18.554 y €19.300 y	€20.520 y €21.664 y	€22.373 y €23.293 y							
13.00	€11.143 y €11.926 y	€12.955 y	€13.738 y €14.521 y	€15.304 y €16.087 y	€16.870 y €17.672 y	€18.455 y	€18.825 y €19.581 y	€20.845 y €22.020 y	€22.740 y €23.580 y							
13.50	€12.496 y €13.460 y	€14.688 y	€15.662 y €16.639 y	€17.602 y €18.565 y	€19.511 y €20.475 y	€21.492 y	€21.959 y €22.924 y	€23.749 y €25.117 y	€25.986 y €27.097 y							
14.00	€12.673 y €13.739 y	€14.895 y	€15.881 y €16.871 y	€17.846 y €18.822 y	€19.778 y €20.753 y	€21.785 y	€22.265 y €23.245 y	€24.079 y €25.480 y	€26.362 y €27.495 y							
14.50	€12.887 y €13.971 y	€15.155 y	€16.160 y €17.169 y	€18.161 y €19.155 y	€20.127 y €21.119 y	€22.171 y	€22.671 y €23.670 y	€24.516 y €25.961 y	€26.857 y €28.019 y							
15.00	€13.062 y €14.158 y	€15.360 y	€16.377 y €17.399 y	€18.403 y €19.409 y	€20.392 y €21.395 y	€22.463 y	€22.976 y €23.990 y	€24.845 y €26.325 y	€27.233 y €28.418 y							

I PREZZI INCLUDONO IL MOTORE - DRIVE BOX (SAFETY BOX)

I PREZZI INCLUDONO IL MOTORE (SAFETY BOX)

I PREZZI NON INCLUDONO INSTALLAZIONE E IVA.

I PREZZI NON INCLUDONO INSTALLAZIONE E IVA

PER LA SCELTA DELL'ACCIAIO INOX, MAGGIORAZIONE DEL 4% SUL PREZZO DI LISTINO

PER PARTI INOX AGGIUNTA DEL 4% SUL PREZZO DI LISTINO

MOTORE MOTORE

■ 55/17, 85/17

BEAUFORT

°6 °7 °8 °9 °10



VERNICE RAL 8% SUL LISTINO PER SCELTA FUORI DAI 7 STANDARD

VERNICE RAL 8% SUL PREZZO DI LISTINO PER SELEZIONE TRA 7 STANDARD

BRACCIALETTI FLOPER FLOPER EAVES

PANNELLO SEMPLICE 100X50 GRONDA 100X50

COLONNE / COLONNE	ASSE (LUNGHEZZA DELLA GRONDAIA)								
	2.50	3.00	3.50	4.00	4.50				
2	€416	€432	€449	€466	€482				
	5.00	5.50	6.00	6.50	7.00	7.50	8.00	8.50	9.00
3	€660	€677	€693	€710	€727	€744	€760	€777	€794
	9.50	10.00	10.50	11.00	11.50	12.00	12.50	13.00	
4	€971	€988	€ 1.005	€ 1.021	€ 1.038	€ 1.055	€ 1.071	€ 1.088	
	13.50	14.00	14.50	15.00					
5	€ 1.266	€ 1.282	€ 1.299	€ 1.316					



PANNELLO SEMPLICE 120X60 GRONDA 120X60

COLONNE / COLONNE	ASSE (LUNGHEZZA DELLA GRONDAIA)								
	2.50	3.00	3.50	4.00	4.50				
2	€489	€511	€533	€554	€576				
	5.00	5.50	6.00	6.50	7.00	7.50	8.00	8.50	9.00
3	€783	€805	€827	€848	€870	€892	€914	€935	€957
	9.50	10.00	10.50	11.00	11.50	12.00	12.50	13.00	
4	€ 1.164	€ 1.186	€ 1.208	€ 1.229	€ 1.251	€ 1.273	€ 1.295	€ 1.316	
	13.50	14.00	14.50	15.00					
5	€ 1.523	€ 1.545	€ 1.567	€ 1.589					



PANNELLO SEMPLICE 160X80 GRONDA 160X80

COLONNE / COLONNE	ASSE (LUNGHEZZA DELLA GRONDAIA)								
	2.50	3.00	3.50	4.00	4.50				
2	€990	€ 1.033	€ 1.076	€ 1.120	€ 1.163				
	5.00	5.50	6.00	6.50	7.00	7.50	8.00	8.50	9.00
3	€ 1.588	€ 1.631	€ 1.674	€ 1.718	€ 1.761	€ 1.804	€ 1.847	€ 1.891	€ 1.934
	9.50	10.00	10.50	11.00	11.50	12.00	12.50	13.00	
4	€2.359	€2.402	€2.445	€2.489	€2.532	€2.575	€2.618	€2.662	
	13.50	14.00	14.50	15.00					
5	€ 3.087	€ 3.130	€ 3.173	€ 3.217					

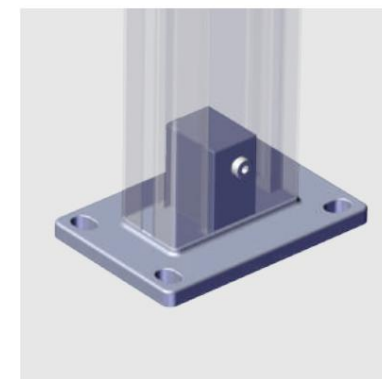

CASSETTO WATERFLOW SISTEMA DI DRENAGGIO DELL'ACQUA

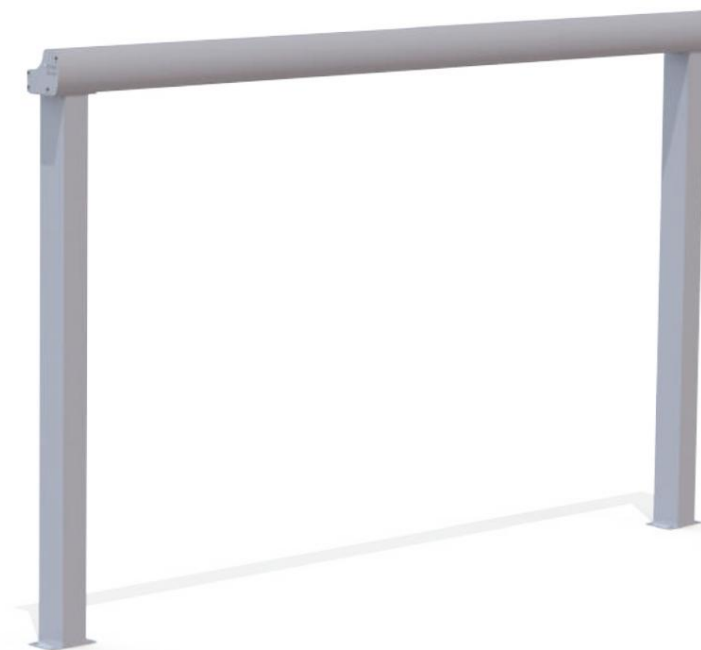
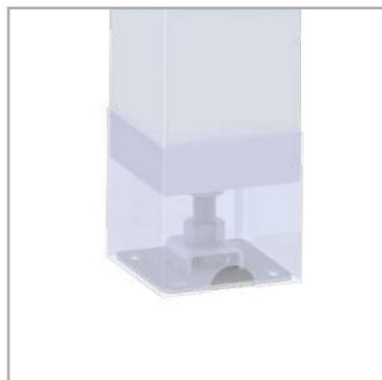

COLONNE / COLONNE	ASSE (LUNGHEZZA DELLA GRONDAIA)								
	2.50	3.00	3.50	4.00	4.50				
2	€677	€712	€747	€782	€817				
	5.00	5.50	6.00	6.50	7.00	7.50	8.00	8.50	9.00
3	€ 1.084	€ 1.119	€ 1.154	€ 1.189	€ 1.224	€ 1.259	€ 1.294	€ 1.329	€ 1.364
	9.50	10.00	10.50	11.00	11.50	12.00	12.50	13.00	
4	€ 1.632	€ 1.667	€ 1.702	€ 1.737	€ 1.772	€ 1.807	€ 1.842	€ 1.877	
	13.50	14.00	14.50	15.00					
5	€2.144	€2.179	€2.214	€2.249					

RACCORDI IN METALLO ZINCATO STANDARD
PARTI METALLICHE STANDARD ZINcate

PER LA SCELTA DELL'ACCIAIO INOX, MAGGIORAZIONE DEL 4% SUL PREZZO DI LISTINO
PER PARTI INOX AGGIUNTA DEL 4% SUL PREZZO DI LISTINO



VERNICE RAL 25% DI SCONTO SUL LISTINO PER SCELTE FUORI DAI 7 STANDARD
VERNICE RAL 25% SUL LISTINO PREZZI PER LA SELEZIONE TRA 2 COLORI STANDARD

I PREZZI NON INCLUDONO INSTALLAZIONE E IVA.
I PREZZI NON INCLUDONO INSTALLAZIONE E IVA

ILLUMINAZIONE A FARETTI LED

FARETTI LED FLOPER

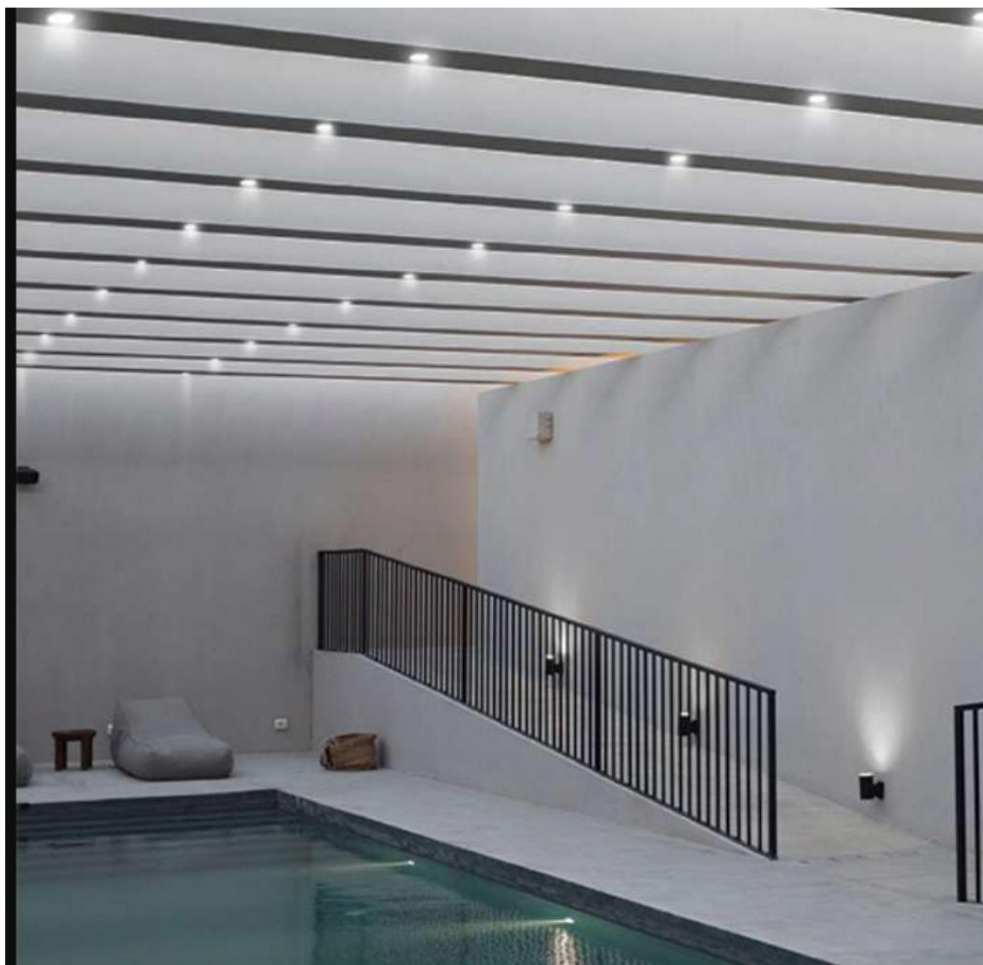

2,5 W - 24 V
350 LUMEN



5W - 24V
710 LUMEN

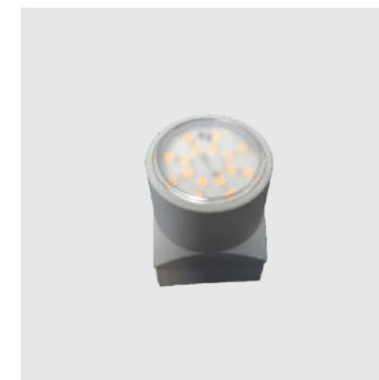

3,5 W - 12 V
500 LUMEN

ASSE / ASSE	SCARICA / PROIEZIONE															
	2.50	3.00	3.50	4.00	4.50	5.00	5.50	6.00	6.50	7.00	7.50	8.00	8.50	9.00	9.50	10.00
	2 DADI CONTRARI / DI CONTROLLO		3 CONTRO / DADI DI CONTROLLO				4 DADI CONTRARI / DI CONTROLLO				5 CONTRO / DADI DI CONTROLLO					
2.50	€610	€611	€665	€666	€667	€668	€722	€723	€724	€725	€779	€781	€782	€783	€784	€785
3.00	€612	€613	€667	€668	€669	€670	€725	€726	€727	€728	€782	€783	€785	€786	€787	€788
3.50	€658	€659	€735	€736	€737	€738	€815	€816	€817	€818	€895	€896	€897	€898	€899	€900
4.00	€659	€660	€737	€739	€740	€741	€818	€819	€820	€821	€898	€899	€900	€901	€902	€903
4.50	€661	€662	€740	€741	€742	€743	€820	€821	€822	€824	€901	€902	€903	€904	€905	€906
5.00	€663	€664	€742	€743	€744	€745	€823	€824	€825	€826	€904	€905	€906	€907	€908	€909
5.50	€709	€710	€810	€811	€812	€813	€913	€914	€915	€916	€ 1.025	€ 1.026	€ 1.027	€ 1.028	€ 1.029	€ 1.030
6.00	€711	€712	€812	€813	€814	€815	€916	€917	€918	€919	€ 1.028	€ 1.029	€ 1.030	€ 1.031	€ 1.032	€ 1.033
6.50	€712	€713	€814	€815	€816	€818	€918	€919	€921	€922	€ 1.031	€ 1.032	€ 1.033	€ 1.034	€ 1.035	€ 1.036
7.00	€714	€715	€816	€818	€819	€820	€921	€922	€923	€924	€ 1.034	€ 1.035	€ 1.036	€ 1.037	€ 1.038	€ 1.039
7.50	€716	€717	€885	€886	€887	€888	€ 1.020	€ 1.021	€ 1.022	€ 1.023	€ 1.147	€ 1.148	€ 1.149	€ 1.150	€ 1.151	€ 1.152
8.00	€762	€763	€887	€888	€889	€890	€ 1.022	€ 1.023	€ 1.024	€ 1.026	€ 1.149	€ 1.151	€ 1.152	€ 1.153	€ 1.154	€ 1.155
8.50	€764	€765	€889	€890	€891	€892	€ 1.025	€ 1.026	€ 1.027	€ 1.028	€ 1.152	€ 1.153	€ 1.155	€ 1.156	€ 1.157	€ 1.158
9.00	€765	€766	€891	€892	€893	€894	€ 1.027	€ 1.029	€ 1.030	€ 1.031	€ 1.155	€ 1.156	€ 1.158	€ 1.159	€ 1.160	€ 1.161
9.50	€767	€768	€959	€960	€961	€962	€ 1.118	€ 1.119	€ 1.120	€ 1.121	€ 1.526	€ 1.527	€ 1.529	€ 1.530	€ 1.531	€ 1.532
10.00	€813	€814	€961	€962	€964	€965	€ 1.120	€ 1.121	€ 1.123	€ 1.124	€ 1.529	€ 1.530	€ 1.532	€ 1.533	€ 1.534	€ 1.535
10.50	€815	€816	€964	€965	€966	€967	€ 1.123	€ 1.124	€ 1.125	€ 1.126	€ 1.532	€ 1.533	€ 1.534	€ 1.536	€ 1.537	€ 1.538
11.00	€817	€818	€966	€967	€968	€969	€ 1.126	€ 1.127	€ 1.128	€ 1.129	€ 1.535	€ 1.536	€ 1.537	€ 1.538	€ 1.540	€ 1.541
11.50	€862	€863	€ 1.042	€ 1.043	€ 1.044	€ 1.045	€ 1.474	€ 1.475	€ 1.476	€ 1.478	€ 1.668	€ 1.669	€ 1.670	€ 1.671	€ 1.673	€ 1.674
12.00	€864	€865	€ 1.044	€ 1.046	€ 1.047	€ 1.048	€ 1.477	€ 1.478	€ 1.479	€ 1.480	€ 1.671	€ 1.672	€ 1.673	€ 1.674	€ 1.675	€ 1.677
12.50	€866	€867	€ 1.047	€ 1.048	€ 1.049	€ 1.050	€ 1.479	€ 1.480	€ 1.482	€ 1.483	€ 1.674	€ 1.675	€ 1.676	€ 1.677	€ 1.678	€ 1.679
13.00	€868	€869	€ 1.049	€ 1.050	€ 1.051	€ 1.052	€ 1.482	€ 1.483	€ 1.484	€ 1.485	€ 1.677	€ 1.678	€ 1.679	€ 1.680	€ 1.681	€ 1.682
13.50	€870	€871	€ 1.051	€ 1.052	€ 1.053	€ 1.054	€ 1.485	€ 1.486	€ 1.487	€ 1.488	€ 1.790	€ 1.791	€ 1.792	€ 1.793	€ 1.794	€ 1.795
14.00	€915	€916	€ 1.119	€ 1.120	€ 1.121	€ 1.122	€ 1.575	€ 1.576	€ 1.577	€ 1.578	€ 1.793	€ 1.794	€ 1.795	€ 1.796	€ 1.797	€ 1.798
14.50	€917	€918	€ 1.121	€ 1.122	€ 1.123	€ 1.125	€ 1.577	€ 1.579	€ 1.580	€ 1.581	€ 1.796	€ 1.797	€ 1.798	€ 1.799	€ 1.800	€ 1.801
15.00	€919	€920	€ 1.123	€ 1.125	€ 1.126	€ 1.127	€ 1.580	€ 1.581	€ 1.582	€ 1.583	€ 1.799	€ 1.800	€ 1.801	€ 1.802	€ 1.803	€ 1.804

**I PREZZI NON INCLUDONO INSTALLAZIONE E IVA.
I PREZZI NON INCLUDONO INSTALLAZIONE E IVA**

COPERTINA FLOPER

COPERTINA FLOPER

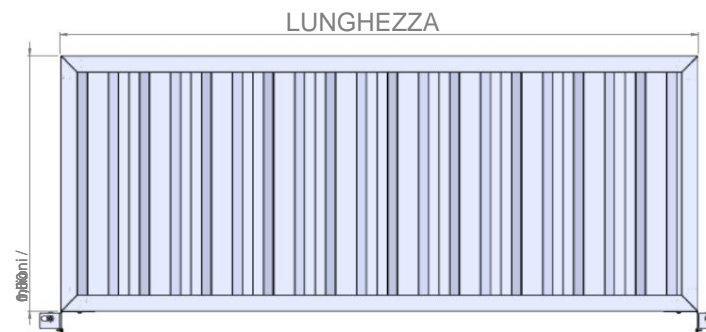

0,60 milioni DISCESA FINO A 4,50 M
SPORGENZA FINO A 4,50 M

0,80 milioni DISCESA FINO A 6,50 M
SPORGENZA FINO A 6,50 M

1,00 milioni CENTRO STORICO FINO A 10.00 M
PROIEZIONE FINO ALLE 10.00 M

LUNGHEZZA	ALTEZZA COPERTURA		
	0,60 milioni	0,80 milioni	1,00 milioni
2.50	€427	€466	€515
3.00	€442	€482	€530
3.50	€495	€547	€611
4.00	€510	€562	€627
4.50	€563	€628	€708
5.00	€629	€695	€776
5.50	€681	€760	€857
6.00	€697	€775	€872
6.50	€749	€840	€953
7.00	€765	€856	€969
7.50	€817	€921	€ 1.050
8.00	€833	€936	€ 1.065
8.50	€886	€ 1.002	€ 1.146
9.00	€901	€ 1.017	€ 1.161
9.50	€ 1.004	€ 1.134	€ 1.295
10.00	€ 1.019	€ 1.149	€ 1.311
10.50	€ 1.072	€ 1.214	€ 1.392
11.00	€ 1.087	€ 1.230	€ 1.407
11.50	€ 1.140	€ 1.295	€ 1.488
12.00	€ 1.155	€ 1.310	€ 1.503
12.50	€ 1.208	€ 1.376	€ 1.584
13.00	€ 1.223	€ 1.391	€ 1.599
13.50	€ 1.326	€ 1.508	€ 1.734
14.00	€ 1.341	€ 1.523	€ 1.749
14.50	€ 1.394	€ 1.589	€ 1.830
15.00	€ 1.409	€ 1.604	€ 1.845

RACCORDI IN METALLO ZINCATO STANDARD**PARTI METALLICHE STANDARD ZINCATE**

PER LA SCELTA DELL'ACCIAIO INOX, MAGGIORAZIONE DEL 3% SUL PREZZO DI LISTINO

PER PARTI INOX AGGIUNTA DEL 3% SUL PREZZO DI LISTINO

I PREZZI NON INCLUDONO INSTALLAZIONE E IVA.**I PREZZI NON INCLUDONO INSTALLAZIONE E IVA**

ORIZZONTE



SKYLINE AUTOSUPPORT SKYLINE AUTOPORTANTE

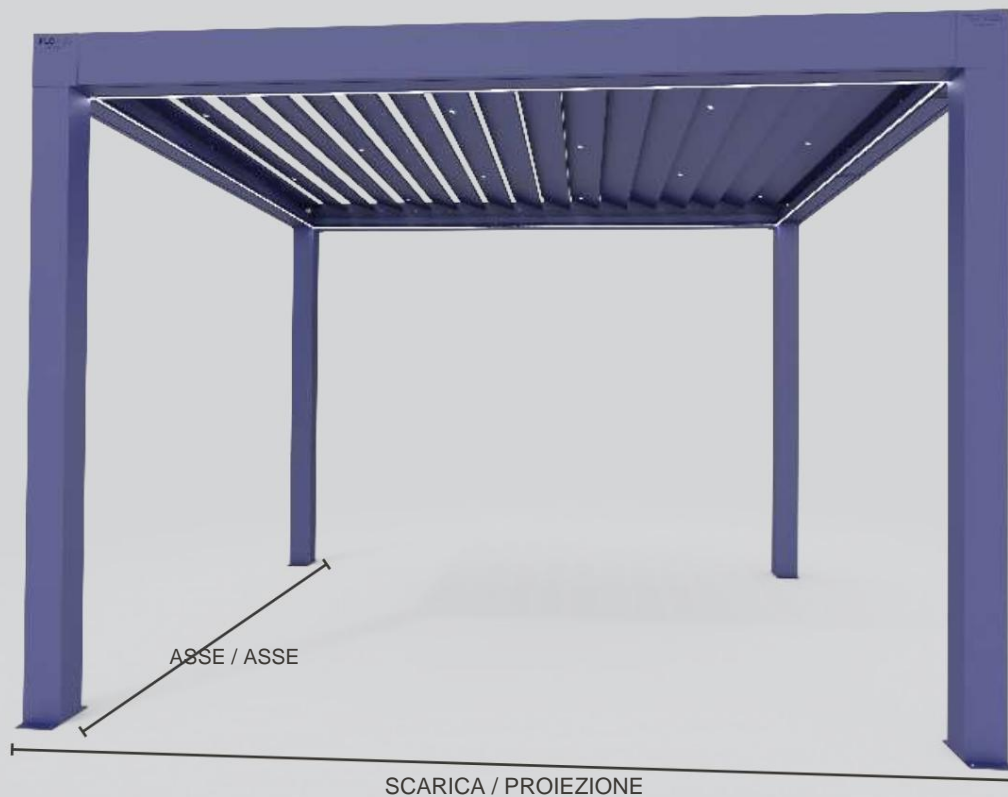

BASE PER COLONNA TELEFONICA
BASE A COLONNA REGOLABILE



BASE PER COLONNA INCASSATA
BASE PER COLONNA INCASSATA

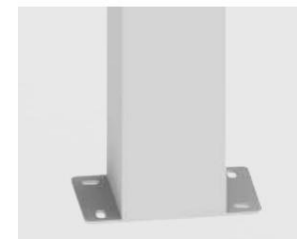

BASE PER COLONNA STANDARD
BASE PER COLONNA STANDARD

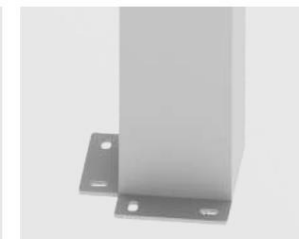

BASE COLONNA ANGOLARE
BASE DELLA COLONNA ANGOLATA



RACCORDI IN METALLO ZINCATO STANDARD PARTI METALLICHE STANDARD ZINCATE



COLORI STANDARD

LUCENTEZZA

ZABULINO DI ZIMIRELLA



OPZIONE DI INSTALLAZIONE DEL SISTEMA RIDO

SCELTA DEL POSIZIONAMENTO DEL SISTEMA DI TENDE

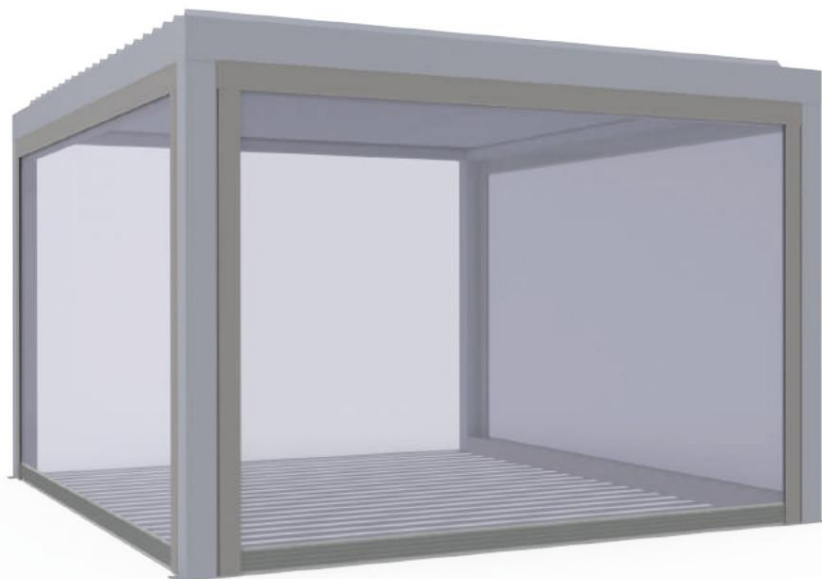
**INSTALLAZIONE DEL MOTORE ALL'INTERNO DEL FLUSSO D'ACQUA**

POSIZIONAMENTO DEL MOTORE ALL'INTERNO DELLA GRONDAIA



ASSALE / ASSE	SCARICA / PROIEZIONE																						
	2.37	2.57	2.77	2.97	3.17	3.37	3.57	3.77	3.97	4.17	4.37	4.57	4.77	4.97	5.17	5.37	5.57	5.77	5.97				
2.00	€6.384	€6.579	€6.769	€6.964	€7.156		€7.349	€7.541	€7.733	€7.925	€8.117		€8.309	€8.501	€8.692	€8.883	€9.074		€9.265	€10.015	€10.205	€10.395	
2.50	€6.726	€6.946	€7.160	€7.380	€7.597		€7.814	€8.031	€8.247	€8.464	€8.680		€8.896	€9.112	€9.328	€9.544	€9.759		€9.975	€10.748	€11.024	€11.239	
3.00	€7.068	€7.313	€7.551	€7.796	€8.037		€8.279	€8.520	€8.761	€9.002	€9.243		€9.484	€9.724	€9.965	€10.205	€10.506	€10.745	€11.543	€11.782	€12.021		
3.50	€7.410	€7.680	€7.942	€8.212	€8.478		€8.744	€9.010	€9.275	€9.541	€9.806	€10.071	€10.336	€10.662	€10.926	€11.749	€12.013	€12.277	€12.540	€12.803			
4.00	€7.752	€8.047	€8.334	€8.628	€8.918		€9.209	€9.499	€9.790	€10.080	€10.369	€10.720	€11.009	€11.298	€11.587	€12.434	€12.723	€13.010	€13.298	€13.585			
4.50	€8.095	€8.414	€8.725	€9.044	€9.359		€9.674	€9.989	€10.304	€10.618	€10.993	€11.307	€11.621	€11.935	€12.248	€13.119	€13.432	€13.744	€14.056	€14.368			
5.00	€8.437	€8.781	€9.116	€9.460	€9.799	€10.139	€10.479	€10.818	€11.218	€11.557	€11.895	€12.233	€12.571	€12.908	€13.804	€14.141	€14.478	€14.814	€15.150				

ILLUMINAZIONE LED RGB-W 16X8MM NON INCLUSA

LA STRISCIA LED RGB-W 16X8MM NON È INCLUSA

PER LA SCELTA DELL'ACCIAIO INOX, MAGGIORAZIONE DEL 5% SUL PREZZO DI LISTINO

PER PARTI INOX AGGIUNTA DEL 5% SUL PREZZO DI LISTINO

I PREZZI NON INCLUDONO INSTALLAZIONE E IVA.

I PREZZI NON INCLUDONO INSTALLAZIONE E IVA

MOTORE MOTORE

■ 1000N, 1500N



VERNICE RAL 10% SUL LISTINO PER SCELTA FUORI DAI 7 STANDARD

VERNICE RAL 10% SUL LISTINO PREZZI PER SELEZIONE SU 7 COLORI STANDARD

SKYLINE MONTAGGIO A PARETE

SKYLINE MONTAGGIO A PARETE



RACCORDI IN METALLO ZINCATO STANDARD
PARTI METALLICHE STANDARD ZINCATE

PER LA SCELTA DELL'INOX SOVRAPPREZZO DEL
4,5% SUL LISTINO PREZZI PER I PEZZI INOX
ULTERIORE 4,5% SUL LISTINO PREZZI

ASSALE / ASSE	SCARICA / PROIEZIONE																		
	2.37	2.57	2.77	2.97	3.17	3.37	3.57	3.77	3.97	4.17	4.37	4.57	4.77	4.97	5.17	5.37	5.57	5.77	5.97
2.00	€5.983	€6.182	€6.374	€6.572	€6.767	€6.963	€7.158	€7.353	€7.549	€7.743	€7.938	€8.133	€8.327	€8.521	€8.716	€8.909	€9.103	€9.297	€9.491
2.50	€6.330	€6.554	€6.771	€6.994	€7.214	€7.435	€7.655	€7.875	€8.095	€8.315	€8.534	€8.753	€8.973	€9.192	€9.410	€9.629	€10.182	€10.462	€10.680
3.00	€6.677	€6.926	€7.168	€7.416	€7.661	€7.907	€8.152	€8.397	€8.641	€8.886	€9.130	€9.374	€9.618	€9.862	€10.107	€10.411	€10.988	€11.231	€11.474
3.50	€7.024	€7.298	€7.565	€7.839	€8.108	€8.378	€8.648	€8.918	€9.188	€9.457	€9.726	€9.995	€10.326	€10.594	€11.197	€11.465	€11.733	€12.000	€12.267
4.00	€7.372	€7.671	€7.962	€8.261	€8.555	€8.850	€9.145	€9.440	€9.734	€10.028	€10.384	€10.678	€10.971	€11.264	€11.892	€12.185	€12.477	€12.769	€13.061
4.50	€7.719	€8.043	€8.359	€8.683	€9.002	€9.322	€9.642	€9.961	€10.280	€10.661	€10.980	€11.298	€11.617	€11.935	€12.587	€12.904	€13.221	€13.538	€13.854
5.00	€8.066	€8.415	€8.756	€9.105	€9.449	€9.794	€10.138	€10.483	€10.889	€11.233	€11.576	€11.919	€12.262	€12.605	€13.292	€13.624	€13.966	€14.307	€14.648

ILLUMINAZIONE LED RGB-W 16X8MM NON INCLUSA
LA STRISCIA LED RGB-W 16X8MM NON È INCLUSA

MOTORE MOTORE
■ 1000N, □ 1500N

I PREZZI NON INCLUDONO INSTALLAZIONE E IVA. I PREZZI NON INCLUDONO INSTALLAZIONE E IVA.



GARANZIA
5 ANNI
GARANZIA

COLORI STANDARD

Colore RAL 1013

9010

7040

1019



9005

7021

8014

LUCENTEZZA

ZABULINO DI ZIMIRELLA



VERNICE RAL 10% SUL LISTINO PER SCELTA FUORI
DAI 7 STANDARD
VERNICE RAL 10% SUL PREZZO DI LISTINO PER
SELEZIONE TRA 7 COLORI STANDARD

ORIZZONTE

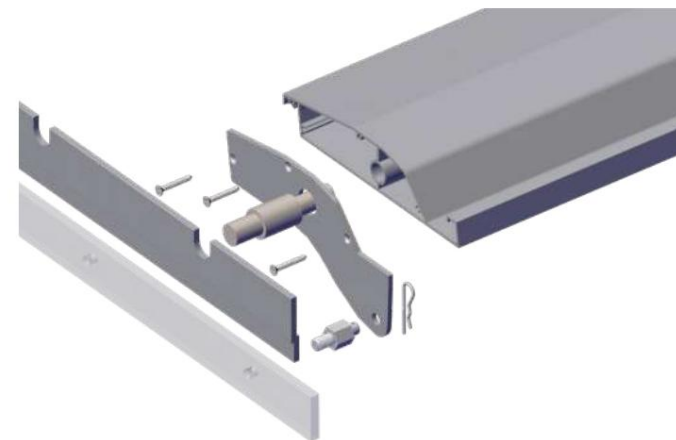

RACCORDI IN METALLO ZINCATO STANDARD
PARTI METALLICHE STANDARD ZINCATO

PER LA SCELTA DELL'INOX SOVRAPPREZZO DEL
4% SUL LISTINO PREZZI PER I PEZZI INOX
EXTRA 4% SUL PREZZO DI LISTINO

ASSALE / ASSE	SCARICA / PROIEZIONE																					
	2.37	2.57	2.77	2.97	3.17	3.37	3.57	3.77	3.97	4.17	4.37	4.57	4.77	4.97	5.17	5.37	5.57	5.77	5.97			
2.00	€ 5.406	€5.603	€5.795	€5.992	€6.186		€6.380	€6.574	€6.768	€6.962	€7.156		€7.349	€7.543	€7.736	€7.929	€8.122		€8.315	€8.507	€8.700	€8.892
2.50	€ 5.751	€5.973	€6.189	€6.411	€6.629		€6.848	€7.067	€7.286	€7.505	€7.723		€7.941	€8.159	€8.377	€8.594	€8.812		€ 9.029	€9.246	€9.525	€9.741
3.00	€6.096	€6.343	€6.583	€6.830	€7.073		€7.317	€7.560	€7.804	€8.047	€8.290		€8.533	€8.775	€9.018	€9.260	€9.563		€9.805	€10.047	€10.288	€10.529
3.50	€6.440	€6.712	€6.977	€7.249	€7.517		€7.785	€8.054	€8.322	€8.589	€8.857		€ 9.124	€9.392	€9.720	€9.987	€10.253	€10.520	€10.786	€11.052	€11.317	
4.00	€6.785	€7.082	€7.371	€7.668	€7.961		€8.254	€8.547	€8.839	€9.132	€9.424		€9.778	€10.069	€10.361	€10.652	€10.943	€11.234	€11.525	€11.815	€12.105	
4.50	€7.129	€7.451	€7.765	€8.087	€8.404		€8.722	€9.040	€9.357	€9.674	€10.053	€10.369	€10.686	€11.002	€11.318	€11.633	€11.949	€12.264	€12.578	€12.893		
5.00	€7.474	€7.821	€8.159	€8.506	€8.848		€ 9.191	€9.533	€9.875	€10.278	€10.620	€10.961	€11.302	€11.643	€11.983	€12.323	€12.663	€13.003	€13.342	€13.681		

ILLUMINAZIONE LED RGB-W 16X8MM NON INCLUSA
LA STRISCIA LED RGB-W 16X8MM NON È INCLUSA

MOTORE MOTORE
■ 1000N, 1500N

I PREZZI NON INCLUDONO INSTALLAZIONE E IVA. I PREZZI NON INCLUDONO INSTALLAZIONE E IVA.



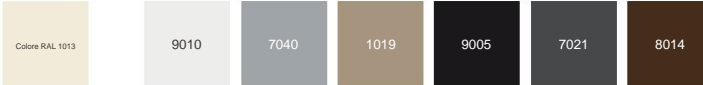

GARANZIA
5 ANNI
GARANZIA

Colori RAL 1013



LUCENTEZZA

ZABULINO DI ZIMIRELLA



VERNICE RAL 10% SUL LISTINO PER SCELTA FUORI
DAI 7 STANDARD
VERNICE RAL 10% SUL PREZZO DI LISTINO PER
SELEZIONE TRA 7 COLORI STANDARD

FORMULA



FORMULA DI AUTOSOSTEGNO FORMULA AUTONOMA

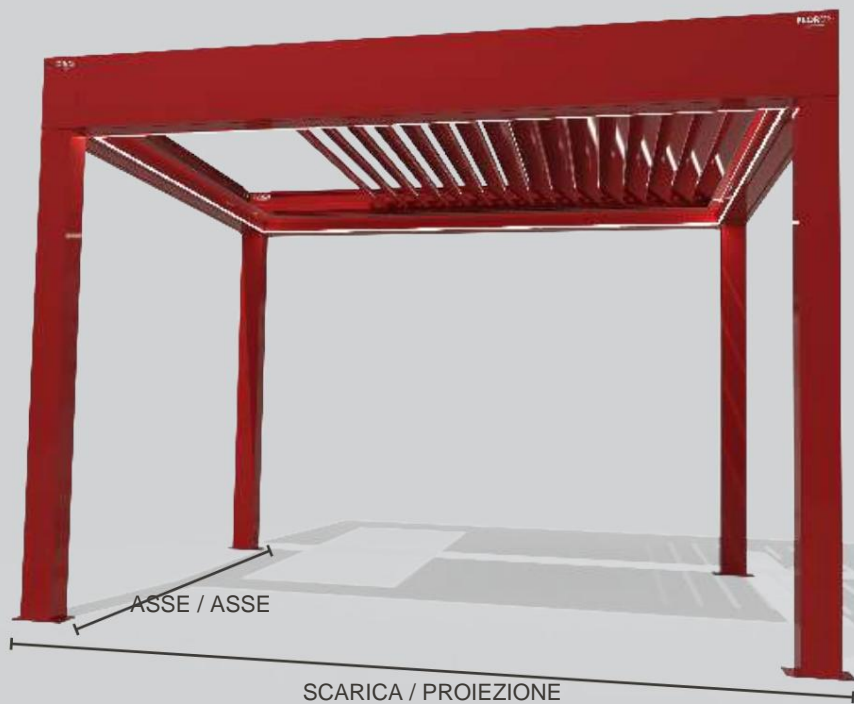

FORMULA PERGOLA APERTA
FORMULA PERGOLA RETRATTA



FORMULA PERGOLA CHIUSA
FORMULA PERGOLA CHIUSA



BASE PER COLONNA INCASSATA
BASE PER COLONNA INCASSATA



BASE PER COLONNA TELEFONICA
BASE A COLONNA REGOLABILE



BASE COLONNA ANGOLARE
BASE DELLA COLONNA ANGOLATA

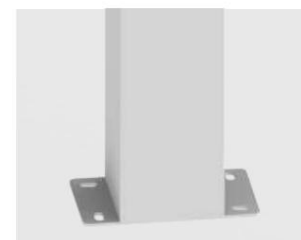

BASE PER COLONNA STANDARD
BASE PER COLONNA STANDARD

RACCORDI IN METALLO ZINCATO STANDARD
PARTI METALLICHE STANDARD ZINCATE

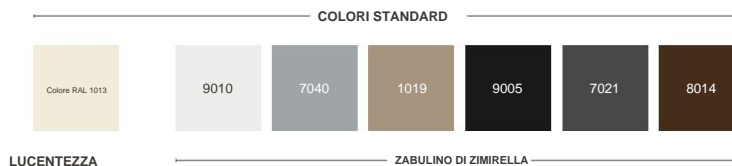

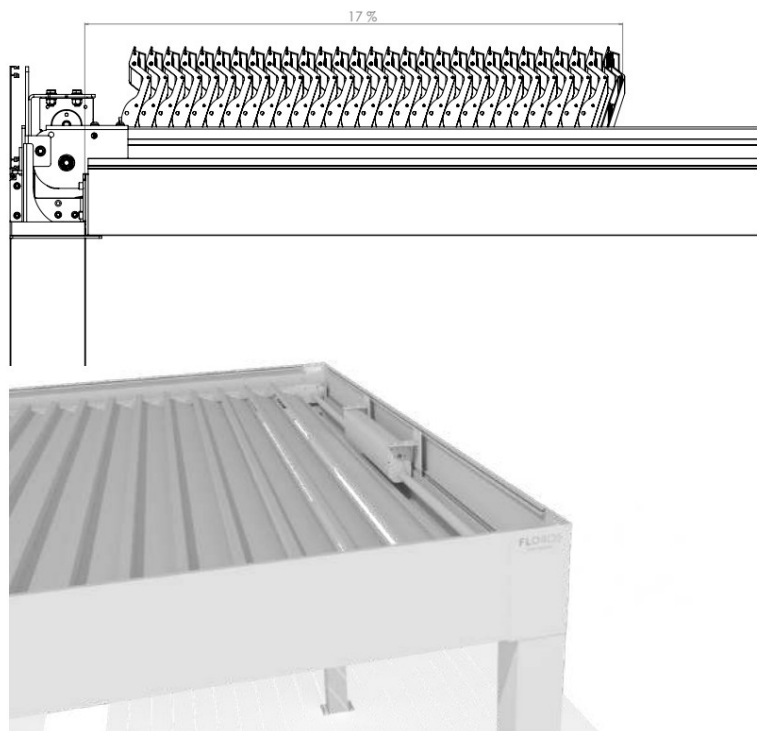

RED



GREEN

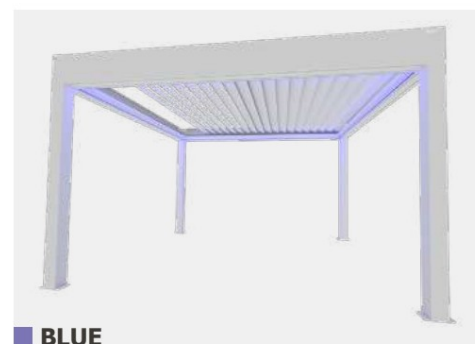

BLUE



WHITE

ΑΞΟΝΑΣ / AXIS	ΚΑΤΕΒΑΣΜΑ / PROJECTION																		
	2,42	2,61	2,81	3,00	3,19	3,39	3,58	3,77	3,96	4,16	4,35	4,54	4,74	4,93	5,12	5,32	5,51	5,70	5,89
2,00	9.288 €	9.647 €	10.003 €	10.348 €	10.707 €	11.067 €	11.403 €	11.761 €	12.107 €	12.466 €	12.803 €	13.258 €	13.604 €	14.341 €	14.683 €	15.041 €	15.397 €	15.745 €	16.102 €
2,50	9.699 €	10.085 €	10.468 €	10.840 €	11.225 €	11.613 €	11.975 €	12.360 €	12.732 €	13.119 €	13.482 €	13.964 €	14.336 €	15.100 €	15.468 €	15.854 €	16.237 €	16.612 €	16.995 €
3,00	10.109 €	10.522 €	10.932 €	11.331 €	11.744 €	12.159 €	12.547 €	12.959 €	13.358 €	13.771 €	14.161 €	14.670 €	15.069 €	15.859 €	16.254 €	16.667 €	17.077 €	17.479 €	17.889 €
3,50	10.520 €	10.960 €	11.397 €	11.823 €	12.263 €	12.705 €	13.119 €	13.558 €	13.983 €	14.424 €	14.840 €	15.757 €	16.181 €	16.619 €	17.040 €	17.479 €	17.917 €	18.346 €	18.783 €
4,00	10.930 €	11.398 €	11.862 €	12.314 €	12.782 €	13.251 €	13.691 €	14.157 €	14.609 €	15.077 €	15.519 €	16.463 €	16.914 €	17.378 €	17.825 €	18.292 €	18.756 €	19.212 €	19.677 €
4,50	11.341 €	11.835 €	12.326 €	12.806 €	13.300 €	13.797 €	14.263 €	14.756 €	15.234 €	15.729 €	16.198 €	17.169 €	17.646 €	18.138 €	18.611 €	19.105 €	19.596 €	20.079 €	20.570 €
5,00	11.751 €	12.273 €	12.791 €	13.298 €	13.819 €	14.343 €	14.835 €	15.355 €	15.860 €	16.382 €	16.877 €	17.875 €	18.378 €	18.897 €	19.397 €	19.917 €	20.436 €	20.946 €	21.464 €

Ο ΦΩΤΙΣΜΟΣ LED ΤΑΙΝΙΑ RGB-W 16X8MM ΔΕΝ ΠΕΡΙΛΑΜΒΑΝΕΤΑΙ
LED LIGHT STRIP RGB-W 16X8MM IS NOT INCLUDED

MOTEP MOTOR
 85/17

ΓΙΑ ΕΠΙΛΟΓΗ ΙΝΟΧ ΕΠΙΒΑΡΥΝΣΗ 4% ΕΠΙ ΤΟΥ ΤΙΜΟΚΑΤΑΛΟΓΟΥ
FOR INOX PARTS EXTRA 4% UPON PRICELIST

ΣΤΙΣ ΤΙΜΕΣ ΔΕΝ ΠΕΡΙΛΑΜΒΑΝΟΝΤΑΙ Η ΕΓΚΑΤΑΣΤΑΣΗ ΚΑΙ Ο Φ.Π.Α.
PRICES DO NOT INCLUDE INSTALLATION AND VAT



RAL ΒΑΦΗ 7% ΕΠΙ ΤΟΥ ΤΙΜΟΚΑΤΑΛΟΓΟΥ ΓΙΑ
ΕΠΙΛΟΓΗ ΕΚΤΟΣ ΤΩΝ 7 STANDARD
RAL PAINT 7% UPON PRICELIST FOR SELECTION
OUT OF 7 STANDARD COLORS

FORMULA MONTAGGIO A PARETE FORMULA MONTAGGIO A PARETE

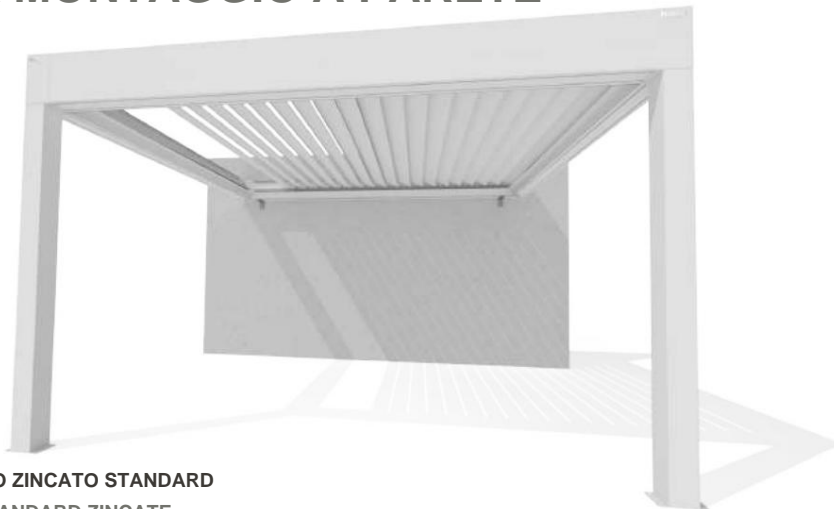

RACCORDI IN METALLO ZINCATO STANDARD
PARTI METALLICHE STANDARD ZINCATE

PER LA SCELTA DELL'INOX MAGGIORAZIONE DEL
3,50% SUL LISTINO PREZZI PER PARTI INOX EXTRA
3,50% SUL PREZZO DI LISTINO

ASSALE / ASSE	SCARICA / PROIEZIONE																						
	2.42	2.61	2.81	3.00	3.19	3.39	3.58	3.77	3.96	4.16	4.35	4.54	4.74	4.93	5.12	5.32	5.51	5.70	5.89				
2.00	€8.906	€9.265	€9.621	€9.966	€10.325	€10.686	€11.022	€11.380	€11.726	€12.085	€12.422	€12.878	€13.224	€13.961	€14.303	€14.661	€15.018	€15.366	€15.722				
2.50	€ 9.317	€ 9.702	€ 10.086	€ 10.458	€ 10.844	€ 11.231	€ 11.594	€ 11.979	€ 12.351	€ 12.738	€ 13.101	€ 13.584	€ 13.956	€ 14.720	€ 15.089	€ 15.474	€ 15.857	€ 16.232	€ 16.616				
3.00	€9.727	€10.140	€10.550	€10.949	€11.362	€11.777	€12.166	€12.578	€12.977	€13.391	€13.780	€14.290	€14.689	€15.479	€15.874	€16.287	€16.697	€17.099	€17.509				
3.50	€ 10.137	€ 10.578	€ 11.015	€ 11.441	€ 11.881	€ 12.323	€ 12.738	€ 13.177	€ 13.602	€ 14.043	€ 14.459	€ 15.376	€ 15.801	€ 16.239	€ 16.660	€ 17.100	€ 17.537	€ 17.966	€ 18.403				
4.00	€ 10.548	€ 11.015	€ 11.479	€ 11.933	€ 12.400	€ 12.869	€ 13.310	€ 13.776	€ 14.228	€ 14.695	€ 15.138	€ 16.082	€ 16.533	€ 16.998	€ 17.446	€ 17.912	€ 18.377	€ 18.833	€ 19.297				
4.50	€ 10.958	€ 11.453	€ 11.944	€ 12.424	€ 12.913	€ 13.415	€ 13.882	€ 14.375	€ 14.853	€ 15.345	€ 15.817	€ 16.788	€ 17.266	€ 17.758	€ 18.231	€ 18.725	€ 19.216	€ 19.699	€ 20.191				
5.00	€ 11.369	€ 11.890	€ 12.409	€ 12.916	€ 13.437	€ 13.961	€ 14.453	€ 14.974	€ 15.479	€ 16.001	€ 16.496	€ 17.494	€ 17.998	€ 18.517	€ 19.017	€ 19.538	€ 20.056	€ 20.566	€ 21.084				

ILLUMINAZIONE LED RGB-W 16X8MM NON INCLUSA
LA STRISCIA LED RGB-W 16X8MM NON È INCLUSA

MOTORE MOTORE
 85/17

I PREZZI NON INCLUDONO INSTALLAZIONE E IVA. I PREZZI NON INCLUDONO INSTALLAZIONE E IVA.

VERNICE RAL 7% SUL LISTINO
PER SCELTA FUORI DAI 7 STANDARD

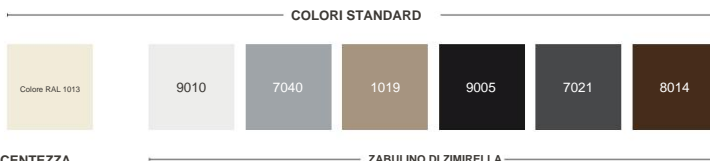

VERNICE RAL 7% SUL PREZZO DI LISTINO PER
SELEZIONE TRA 7 STANDARD
COLORI

FORMULA

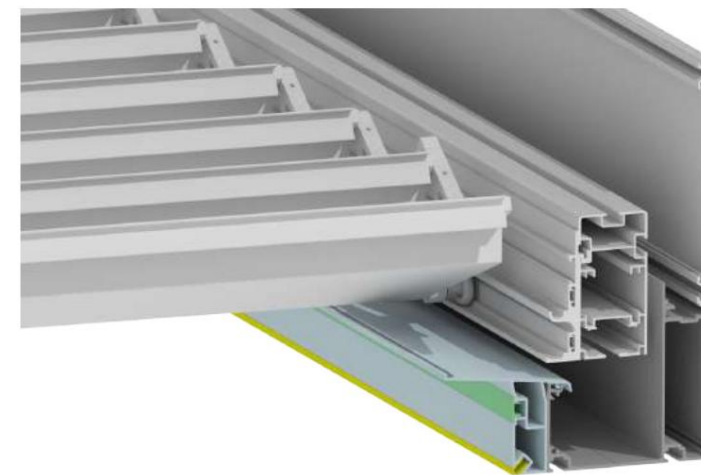

RACCORDI IN METALLO ZINCATO STANDARD
PARTI METALLICHE STANDARD ZINCATE

PER LA SCELTA DELL'INOX SOVRAPPREZZO DEL
3% SUL LISTINO PREZZI PER I PEZZI INOX
3% EXTRA SUL PREZZO DI LISTINO

ASSALE / ASSE	SCARICA / PROIEZIONE																		
	2.42	2.61	2.81	3.00	3.19	3.39	3.58	3.77	3.96	4.16	4.35	4.54	4.74	4.93	5.12	5.32	5.51	5.70	5.89
2.00	€8.524	€8.882	€9.239	€9.584	€9.943	€10.304	€10.641	€10.999	€11.345	€11.705	€12.042	€12.497	€12.844	€13.200	€13.544	€13.902	€14.258	€14.606	€14.963
2.50	€8.934	€9.320	€9.704	€10.076	€10.462	€10.849	€11.213	€11.598	€11.971	€12.357	€12.721	€13.203	€13.576	€13.960	€14.329	€14.715	€15.098	€15.473	€15.856
3.00	€9.345	€9.758	€10.168	€10.568	€10.980	€11.395	€11.785	€12.197	€12.596	€13.010	€13.400	€13.909	€14.309	€14.719	€15.115	€15.527	€15.938	€16.340	€16.750
3.50	€9.755	€10.195	€10.633	€11.059	€11.499	€11.941	€12.357	€12.796	€13.222	€13.662	€14.079	€14.615	€15.041	€15.479	€15.901	€16.340	€16.777	€17.206	€17.644
4.00	€10.165	€10.633	€11.097	€11.551	€12.018	€12.487	€12.928	€13.395	€13.847	€14.315	€14.758	€15.321	€15.773	€16.238	€16.686	€17.153	€17.617	€18.073	€18.537
4.50	€10.576	€11.071	€11.562	€12.042	€12.536	€13.033	€13.500	€13.994	€14.473	€14.968	€15.437	€16.027	€16.506	€16.997	€17.472	€17.966	€18.457	€18.940	€19.431
5.00	€10.986	€11.508	€12.026	€12.534	€13.055	€13.579	€14.072	€14.593	€15.098	€15.620	€16.116	€16.734	€17.238	€17.757	€18.258	€18.778	€19.296	€19.807	€20.325

ILLUMINAZIONE LED RGB-W 16X8MM NON INCLUSA
LA STRISCIA LED RGB-W 16X8MM NON È INCLUSA

MOTORE MOTORE
 85/17

I PREZZI NON INCLUDONO INSTALLAZIONE E IVA. I PREZZI NON INCLUDONO INSTALLAZIONE E IVA.

VERNICE RAL 7% SUL LISTINO
PER SCELTA FUORI DAI 7 STANDARD

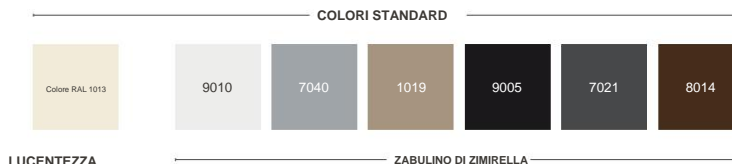

VERNICE RAL 7% SUL PREZZO DI LISTINO PER
SELEZIONE TRA 7 STANDARD
COLORI

OSSERVAZIONI SULL'ILLUMINAZIONE SKYLINE E FORMULA

OSSERVAZIONI PER LE LUCI SKYLINE E FORMULA

CASI INDICATIVI DI ILLUMINAZIONE CON STRISCIA LED INTORNO AL FLUSSO D'ACQUA

CASI INDICATIVI DI ILLUMINAZIONE INTORNO ALLA GRONDAIA CON STRISCIA LED



ESTENSIONE DEL FLUSSO D'ACQUA CON ILLUMINAZIONE LATERALE A LED
ESTENSIONE GRONDAIE CON LUCE LED ANGOLARE

STRISCIA LED RGB-W 16X8MM
STRISCIA LED RGB-W 16X8MM



PROFILO ILLUMINANTE SKYLINE CON ILLUMINAZIONE LED VERTICALE € 20,83/M.
PROFILO ILLUMINANTE SKYLINE CON LUCE LED VERTICALE €20,83/M.

STRISCIA LED RGB-W 16X8MM
STRISCIA LED RGB-W 16X8MM

FOCUS SOTTO L'ALA SKYLINE
ILLUMINAZIONE CON FARETTI SOTTO IL LOUVRE DI SKYLINE

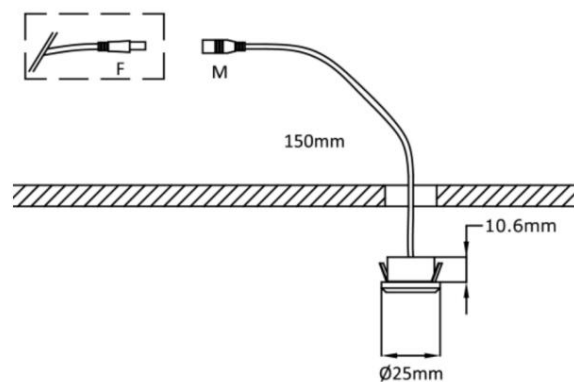
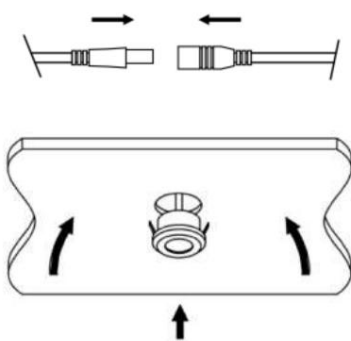

SPOTLIGHT €39,89/TMX
FARETTO € 39,89/UNITÀ

CARTUCCIA EPSI I LON

EPSI I LON CASSETTA

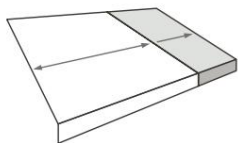

LUNGHEZZA
MIN 3,00 M / MAX 7,00 M

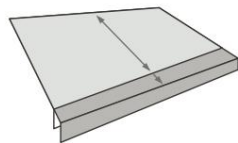

SCARICA PROIEZIONE
MIN 1,80 M / MAX 3,50 M

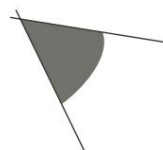

INCLINAZIONE
MIN 0° / MAX 45°

POSSIBILITÀ DI INSTALLARE STRISCE LED ILLUMINANTI
RGB-W 16X8MM CON SUPPLEMENTO
POSSIBILITÀ DI INSTALLARE STRISCE LED RGB-W
16X8MM CON SUPPLEMENTO



MOVIMENTO

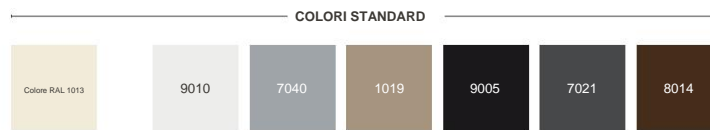

LUCENTEZZA

ZABULINO DI ZIMIRELLA



SCARICAMENTO / PROIEZIONE	ASSE / ASSE								
	3.00	3.50	4.00	4.50	5.00	5.50	6.00	6.50	7.00
1,80	€3.170 ↗	€3.218 ↗	€3.267 ↗	€3.567 ↗	€3.615 ↗	€4.125 ↗	€4.173 ↗	€4.473 ↗	€4.732 ↗
2.00	€3.204 ↗	€3.256 ↗	€3.309 ↗	€3.612 ↗	€3.665 ↗	€4.182 ↗	€4.235 ↗	€4.538 ↗	€4.804 ↗
2.25	€3.245 ↗	€3.302 ↗	€3.359 ↗	€3.668 ↗	€3.725 ↗	€4.034 ↗	€4.309 ↗	€4.617 ↗	€4.674 ↗
2.50	€3.335 ↗	€3.397 ↗	€3.459 ↗	€3.772 ↗	€3.834 ↗	€4.148 ↗	€4.456 ↗	€4.770 ↗	€4.831 ↗
2,75	€3.376 ↗	€3.443 ↗	€3.510 ↗	€3.828 ↗	€3.895 ↗	€4.213 ↗	€4.280 ↗	€4.849 ↗	€4.915 ↗
3.00	-	€3.489 ↗	€3.560 ↗	€3.883 ↗	€3.955 ↗	€4.278 ↗	€4.350 ↗	€4.927 ↗	€4.999 ↗
3.25	-	-	€3.611 ↗	€3.939 ↗	€4.015 ↗	€4.343 ↗	€4.420 ↗	€5.006 ↗	€5.083 ↗
3.50	-	-	-	€3.995 ↗	€4.076 ↗	€4.409 ↗	€4.491 ↗	€5.086 ↗	€5.168 ↗

BEAUFORT

*4 *5 *6



TABELLA DELLE SPECIFICHE

SCARICAMENTO / PROIEZIONE	LUNGHEZZA DELL'ASSE								
	3.00	3.50	4.00	4.50	5.00	5.50	6.00	6.50	7.00
1,80	● ● ●	● ● ●	● ● ●	● ● ●	● ● ●	● ● ● ●	● ● ● ●	● ● ● ● ●	● ● ● ● ●
2.00	● ● ●	● ● ●	● ● ●	● ● ●	● ● ●	● ● ● ●	● ● ● ●	● ● ● ● ●	● ● ● ● ●
2.25	● ● ●	● ● ●	● ● ●	● ● ●	● ● ●	● ● ● ●	● ● ● ●	● ● ● ● ●	● ● ● ● ●
2.50	● ● ●	● ● ●	● ● ●	● ● ●	● ● ●	● ● ● ●	● ● ● ●	● ● ● ● ●	● ● ● ● ●
2,75	● ● ●	● ● ●	● ● ●	● ● ●	● ● ●	● ● ● ●	● ● ● ●	● ● ● ● ●	● ● ● ● ●
3.00		● ● ●	● ● ●	● ● ●	● ● ●	● ● ● ●	● ● ● ●	● ● ● ● ●	● ● ● ● ●
3.25		● ● ●	● ● ●	● ● ●	● ● ●	● ● ● ●	● ● ● ●	● ● ● ● ●	● ● ● ● ●
3.50				● ● ●	● ● ●	● ● ● ●	● ● ● ●	● ● ● ● ●	● ● ● ● ●

● SWIFT II ARMS SWIFT II ARMS

● BASI DI SUPPORTO

TABELLA DELLE LUNGHEZZE MINIME DEGLI ASSI

SISTEMA / SISTEMA	LUNGHEZZA DEL BRACCIO SWIFT II							
	1,50	1,60	1,80	2,00	2,25	2,50	2,75	3,00
CASSETTA EPSII LON	2,10 metri	2,24 metri	2,38 metri	2,65 metri	2,88 metri	3,14 metri	3,38 metri	3,65 metri

IL PREZZO INCLUDE UN MOTORE CORDLESS

IL PREZZO INCLUDE IL MOTORE WIRELESS

I PREZZI NON INCLUDONO INSTALLAZIONE E IVA.

I PREZZI NON INCLUDONO INSTALLAZIONE E IVA

TENDA DA SOLE CLIENTE -8%
SUL PREZZO DI LISTINO

TESSUTO PER TENDE DA SOLE DEL CLIENTE -8%
SUL LISTINO PREZZI



VERNICE RAL 15% DI SCONTO SUL LISTINO PER
SCELTE FUORI DAI 7 STANDARD

VERNICE RAL 15% SUL PREZZO DI LISTINO PER
SELEZIONE TRA 7 COLORI STANDARD

92 FIORI FINE SHADING

CASSETTA ORIZZONTE

CASSETTA ORIZZONTE

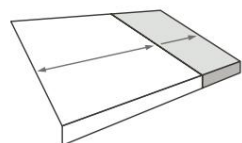
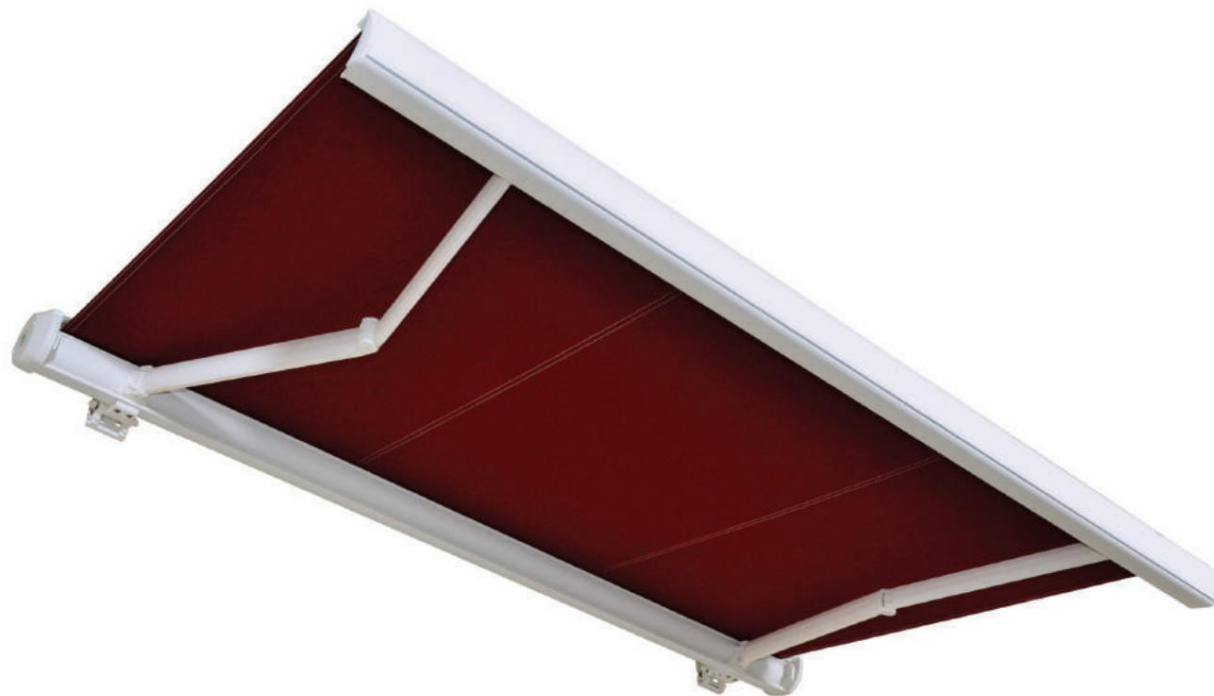

LUNGHEZZA
MIN 3,00 M / MAX 7,00 M

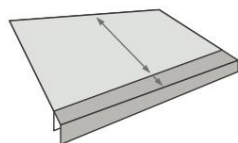

SCARICA PROIEZIONE
MIN 1,60 M / MAX 3,00 M



INCLINAZIONE
MIN 55° / MAX 80°

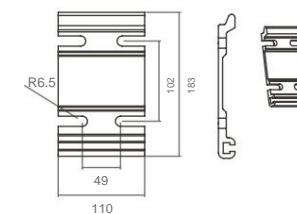
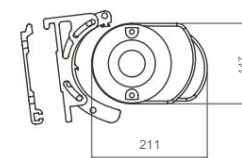
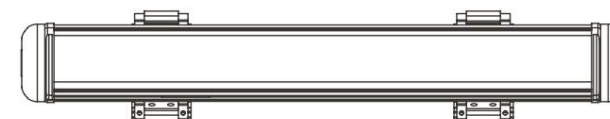

MOVIMENTO

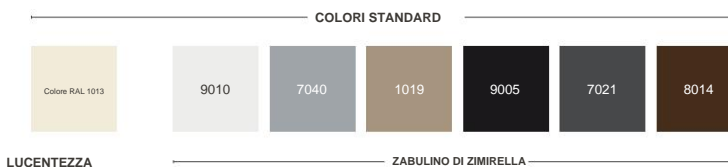

SCARICAMENTO / PROIEZIONE	ASSE / ASSE								
	3.00	3.50	4.00	4.50	5.00	5.50	6.00	6.50	7.00
1,60	€2.173 ↘	€2.216 ↘	€2.260 ↘	€2.408 ↘	€2.451 ↘	€2.766 ↘	€2.810 ↘	€3.125 ↘	€3.168 ↘
1,80	€2.202 ↘	€2.249 ↘	€2.296 ↘	€2.448 ↘	€2.495 ↘	€2.816 ↘	€2.863 ↘	€3.183 ↘	€3.230 ↘
2,00	€2.234 ↘	€2.285 ↘	€2.336 ↘	€2.491 ↘	€2.542 ↘	€2.870 ↘	€2.921 ↘	€3.248 ↘	€3.299 ↘
2,25	€2.272 ↘	€2.328 ↘	€2.384 ↘	€2.544 ↘	€2.600 ↘	€2.935 ↘	€2.991 ↘	€3.326 ↘	€3.382 ↘
2,50	€2.323 ↘	€2.384 ↘	€2.444 ↘	€2.609 ↘	€2.670 ↘	€3.019 ↘	€3.079 ↘	€3.428 ↘	€3.489 ↘
2,75	-	€2.427 ↘	€2.492 ↘	€2.662 ↘	€2.727 ↘	€3.084 ↘	€3.149 ↘	€3.319 ↘	€3.572 ↘
3,00	-	€2.470 ↘	€2.540 ↘	€2.714 ↘	€2.784 ↘	€3.149 ↘	€3.219 ↘	€3.394 ↘	€3.654 ↘

BEAUFORT

*5 *6 

TABELLA DELLE SPECIFICHE

SCARICAMENTO / PROIEZIONE	LUNGHEZZA DELL'ASSE								
	3.00	3.50	4.00	4.50	5.00	5.50	6.00	6.50	7.00
1,60	● ●	● ●	● ●	● ●	● ●	● ● ●	● ● ●	● ● ● ●	● ● ● ●
1,80	● ●	● ●	● ●	● ●	● ●	● ● ●	● ● ●	● ● ● ●	● ● ● ●
2,00	● ●	● ●	● ●	● ●	● ●	● ● ●	● ● ●	● ● ● ●	● ● ● ●
2,25	● ●	● ●	● ●	● ●	● ●	● ● ●	● ● ●	● ● ● ●	● ● ● ●
2,50	● ●	● ●	● ●	● ●	● ●	● ● ●	● ● ●	● ● ● ●	● ● ● ●
2,75		● ●	● ●	● ●	● ●	● ● ●	● ● ●	● ● ●	● ● ● ●
3,00		● ●	● ●	● ●	● ●	● ● ●	● ● ●	● ● ●	● ● ● ●

● BASI DI SUPPORTO PER BRACCI

TABELLA DELLE LUNGHEZZE MINIME DEGLI ASSI

SISTEMA / SISTEMA	LUNGHEZZA DEL BRACCIO							
	1,50	1,60	1,80	2,00	2,25	2,50	2,75	3,00
CASSETTA ORIZZONTE	1,90 m	2,04 m	2,18 m	2,45 m	2,68 m	2,94 m	3,18 m	3,45 m

IL PREZZO INCLUDE UN MOTORE CORDLESS

IL PREZZO INCLUDE IL MOTORE WIRELESS

I PREZZI NON INCLUDONO INSTALLAZIONE E IVA.

I PREZZI NON INCLUDONO INSTALLAZIONE E IVA

TENDA DA SOLE CLIENTE -10% SUL
LISTINO

TESSUTO PER TENDE DA SOLE DEL CLIENTE -10%
SUL LISTINO PREZZI



VERNICE RAL 15% DI
SCONTO SUL LISTINO PER SCELTE
FUORI DAI 7 STANDARD

VERNICE RAL 15% SUL PREZZO DI LISTINO
PER LA SELEZIONE TRA 7 STANDARD
COLORI

PASSEGGIATA



96 FIORI FINE SHADING

TENDA QUADRATA PIAZZA RIDO

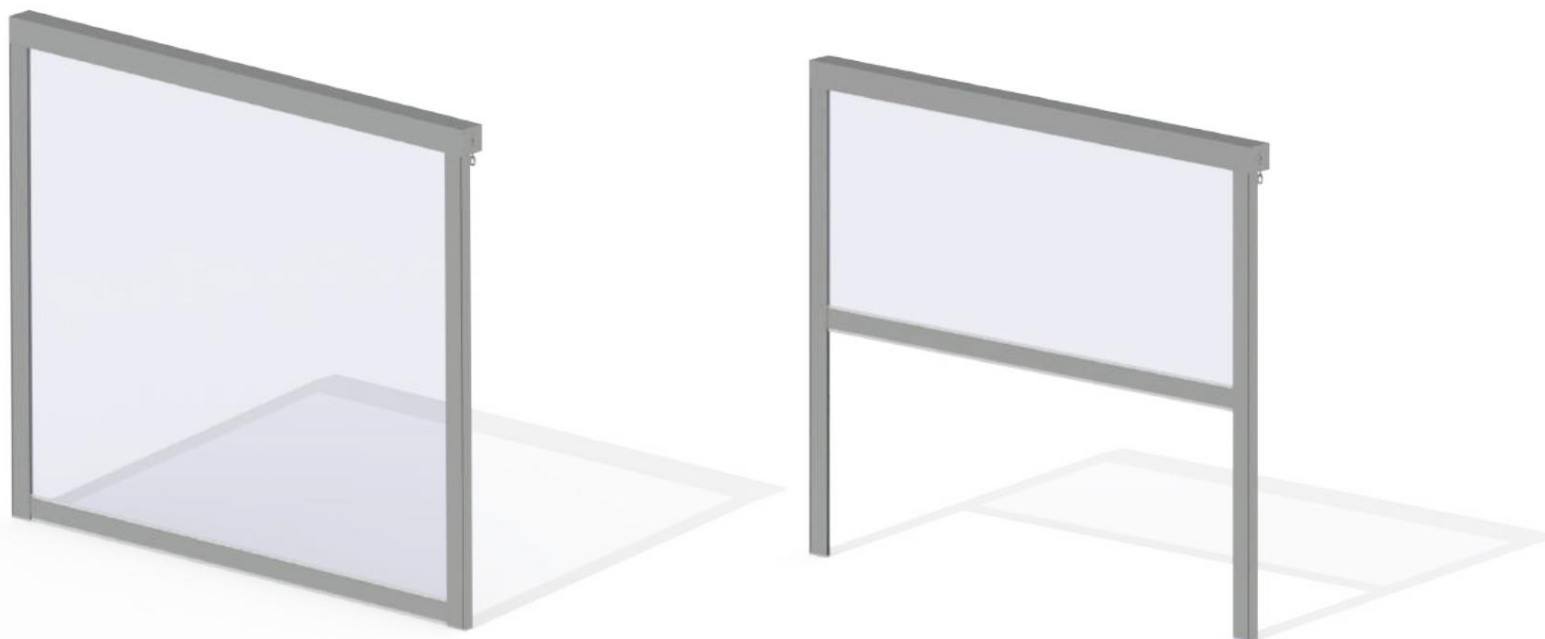

MOVIMENTO

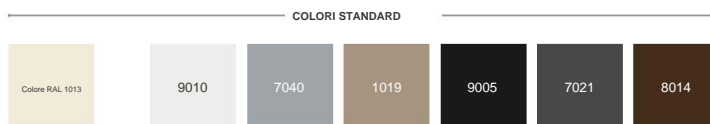

LUCENTEZZA

ZABULINO DI ZIMIRELLA



TESSUTI TECNICI





SCARICAMENTO / PROIEZIONE	LUNGHEZZA DELL'ASSE								
	1,00	1,50	2,00	2,50	3,00	3,50	4,00	4,50	5,00
1,00	€402	€464	€527	€589	€652	€715	€777	€840	€902
1,50	€448	€516	€584	€652	€720	€788	€856	€924	€992
2,00	€495	€568	€641	€715	€788	€862	€935	€ 1.008	€ 1.082
2,50	€541	€620	€699	€777	€856	€935	€ 1.014	€ 1.093	€ 1.171
3,00	€587	€672	€756	€840	€924	€ 1.009	€ 1.093	€ 1.177	€ 1.261
3,50	€634	€723	€813	€903	€992	€ 1.082	€ 1.172	€ 1.261	€ 1.351

CODICE	DESCRIZIONE	PREZZO
355203150	PIASTRA DI GRAVITÀ 70 MM X 10 MM X 1,50 M / PIASTRA DI GRAVITÀ 70 MM X 10 MM X 1,50 M	€29,25
355203200	PIASTRA DI GRAVITÀ 70 MM X 10 MM X 2,00 M / PIASTRA DI GRAVITÀ 70 MM X 10 MM X 2,00 M	€38,99

**I PREZZI NON INCLUDONO INSTALLAZIONE E IVA.
I PREZZI NON INCLUDONO INSTALLAZIONE E IVA**



**VERNICE RAL 20% DI SCONTO SUL LISTINO
PER SCELTE FUORI DAI 7 STANDARD**
VERNICE RAL 20% SUL PREZZO DI LISTINO PER
SELEZIONE TRA 7 COLORI STANDARD

98 FIORI FINE SHADING

TENDA CURVA TENDA CURVA

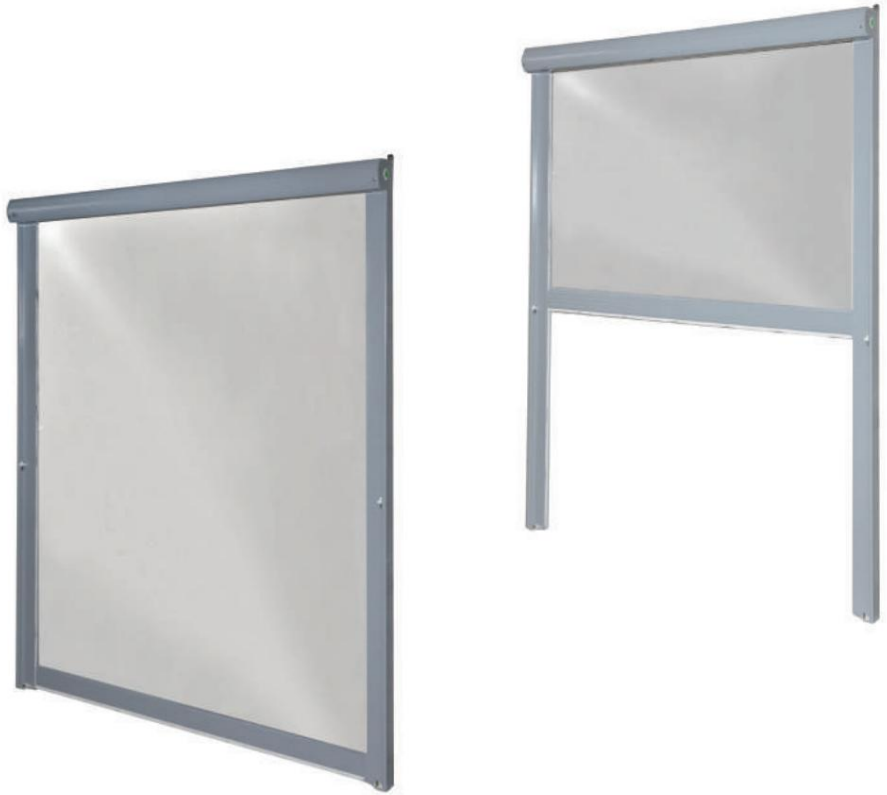
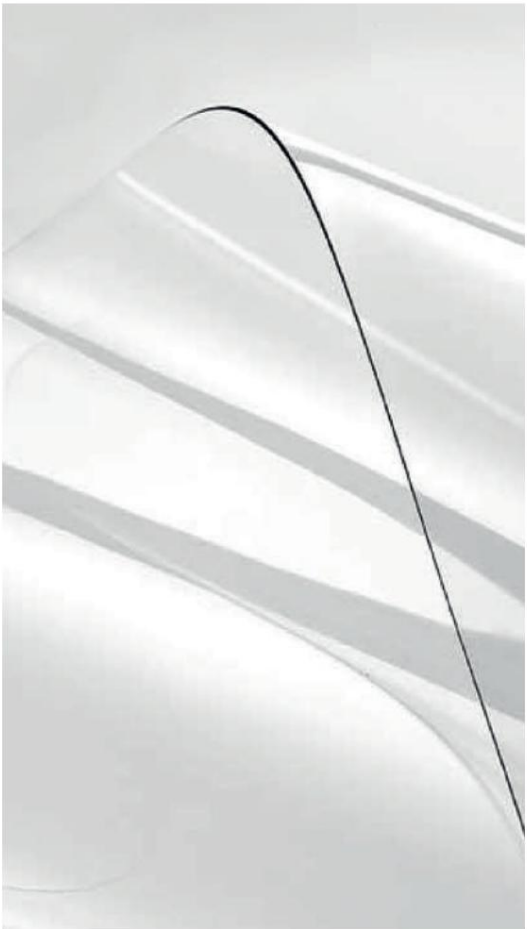











MOVIMENTO

COLORI STANDARD

 Colore RAL 1013	 9010	 7040	 1019	 9005	 7021	 8014
--	---	---	---	--	---	---

LUCENTEZZA

ZABULINO DI ZIMIRELLA





TESSUTI TECNICI





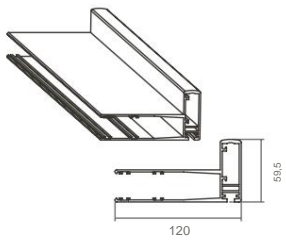

■ 355201

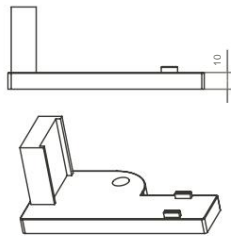

■ 350214

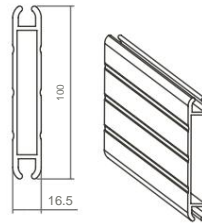

■ 355202

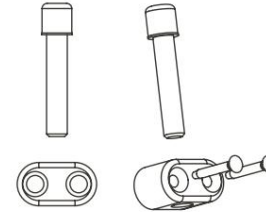

■ 350215

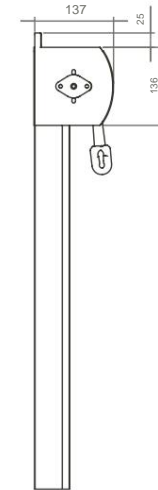

SCARICAMENTO / PROIEZIONE	LUNGHEZZA DELL'ASSE								
	1,00	1,50	2,00	2,50	3,00	3,50	4,00	4,50	5,00
1,00	€378	€429	€480	€531	€582	€633	€684	€735	€786
1,50	€425	€482	€538	€595	€651	€707	€764	€820	€877
2,00	€472	€534	€596	€658	€720	€782	€844	€906	€968
2,50	€520	€587	€654	€722	€789	€857	€924	€992	€ 1.059
3,00	€567	€640	€713	€785	€858	€931	€ 1.004	€ 1.077	€ 1.150
3,50	€614	€692	€771	€849	€927	€ 1.006	€ 1.084	€ 1.163	€ 1.241

CODICE	DESCRIZIONE	PREZZO
355203150	PIASTRA DI GRAVITÀ 70 MM X 10 MM X 1,50 M / PIASTRA DI GRAVITÀ 70 MM X 10 MM X 1,50 M	€29,25
355203200	PIASTRA DI GRAVITÀ 70 MM X 10 MM X 2,00 M / PIASTRA DI GRAVITÀ 70 MM X 10 MM X 2,00 M	€38,99

I PREZZI NON INCLUDONO INSTALLAZIONE E IVA.
I PREZZI NON INCLUDONO INSTALLAZIONE E IVA



**VERNICE RAL 20% DI SCONTO SUL LISTINO
PER SCELTE FUORI DAI 7 STANDARD**
VERNICE RAL 20% SUL PREZZO DI LISTINO PER
SELEZIONE TRA 7 COLORI STANDARD

100 FIORI FINE SHADING

SWIFT I BAR BARA SWIFT I



MOVIMENTO



COLORE STANDARD



TESSUTI TECNICI



DETTAGLI TECNICI - RICAMBI DETTAGLI TECNICI - RICAMBI

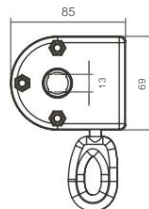
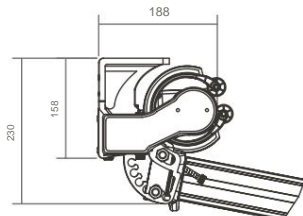
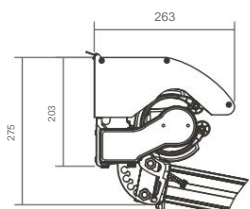

■ 110004

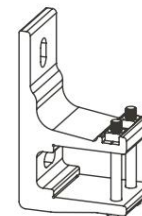

■ 310002

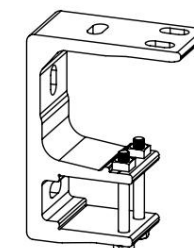

■ 310001

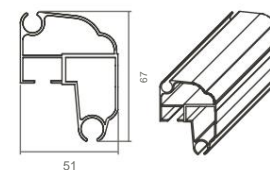
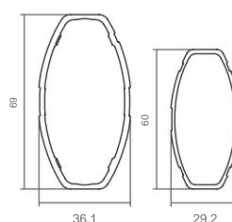
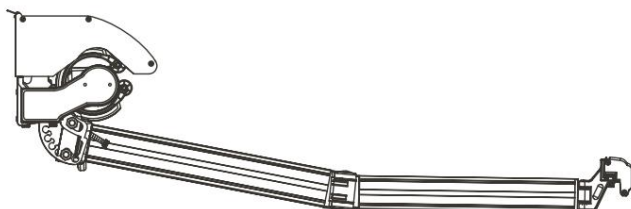

■ 150001

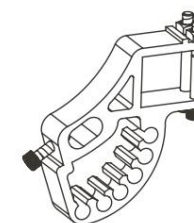

■ 310004

SCARICAMENTO / PROIEZIONE	ASSE / ASSE								
	3.00	3.50	4.00	4.50	5.00	5.50	6.00	6.50	7.00
1,60	€780 ÿ	€837 ÿ	€921 ÿ	€988 ÿ	€ 1.046 ÿ	€1.195 ÿ	€ 1.279 ÿ	€ 1.348 ÿ	€ 1.476 ÿ
1,80	€809 ÿ	€871 ÿ	€959 ÿ	€1.029 ÿ	€ 1.091 ÿ	€ 1.173 ÿ	€ 1.334 ÿ	€ 1.406 ÿ	€ 1.540 ÿ
2,00	€842 ÿ	€907 ÿ	€999 ÿ	€ 1.074 ÿ	€1.139 ÿ	€ 1.225 ÿ	€ 1.393 ÿ	€ 1.469 ÿ	€ 1.534 ÿ
2,25	€881 ÿ	€951 ÿ	€1.048 ÿ	€ 1.128 ÿ	€1.198 ÿ	€ 1.289 ÿ	€ 1.465 ÿ	€ 1.545 ÿ	€ 1.615 ÿ
2,50	€933 ÿ	€1.008 ÿ	€1.110 ÿ	€ 1.194 ÿ	€ 1.269 ÿ	€ 1.365 ÿ	€ 1.466 ÿ	€ 1.641 ÿ	€ 1.716 ÿ
2,75	€973 ÿ	€1.052 ÿ	€1.159 ÿ	€ 1.248 ÿ	€ 1.328 ÿ	€ 1.428 ÿ	€ 1.535 ÿ	€ 1.717 ÿ	€ 1.797 ÿ
3,00	€1.012 ÿ	€ 1.097 ÿ	€ 1.208 ÿ	€ 1.302 ÿ	€ 1.386 ÿ	€ 1.492 ÿ	€ 1.603 ÿ	€ 1.794 ÿ	€ 1.878 ÿ

BEAUFORT

*4 *5 *6

I PREZZI NON INCLUDONO LA COPERTURA

I PREZZI NON INCLUDONO LA COPERTURA

I PREZZI NON INCLUDONO INSTALLAZIONE E IVA.

I PREZZI NON INCLUDONO INSTALLAZIONE E IVA

IL PREZZO È PER LA GESTIONE

IL PREZZO SI RIFERISCE AL COMANDO MANUALE

TENDA DA SOLE CLIENTE -10% SUL

LISTINO

TESSUTO PER TENDE DA SOLE DEL CLIENTE -10%

SUL LISTINO PREZZI

VERNICE RAL 20% SUL
LISTINO PER SCELTA DIVERSA
DAL BIANCO RAL STANDARD

VERNICE RAL 20% SUL PREZZO DI LISTINO
PER SELEZIONE FUORI DAL BIANCO RAL
COLORE STANDARD



102 FIORI FINE SHADING

SWIFT II BAR BARA SWIFT II

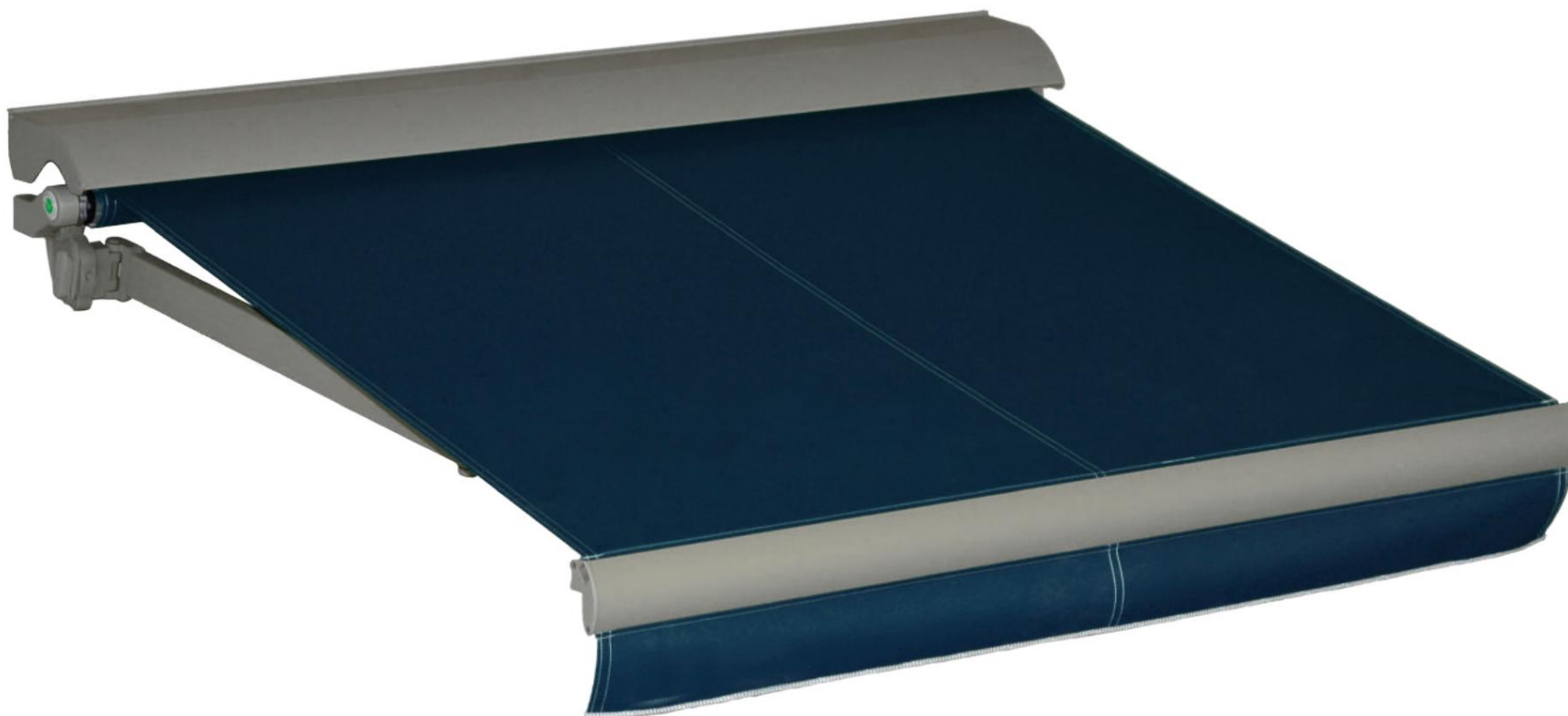

GARANZIA
5 ANNI
GARANZIA

MOVIMENTO



COLORE STANDARD



TESSUTI TECNICI



DETTAGLI TECNICI - RICAMBI DETTAGLI TECNICI - RICAMBI

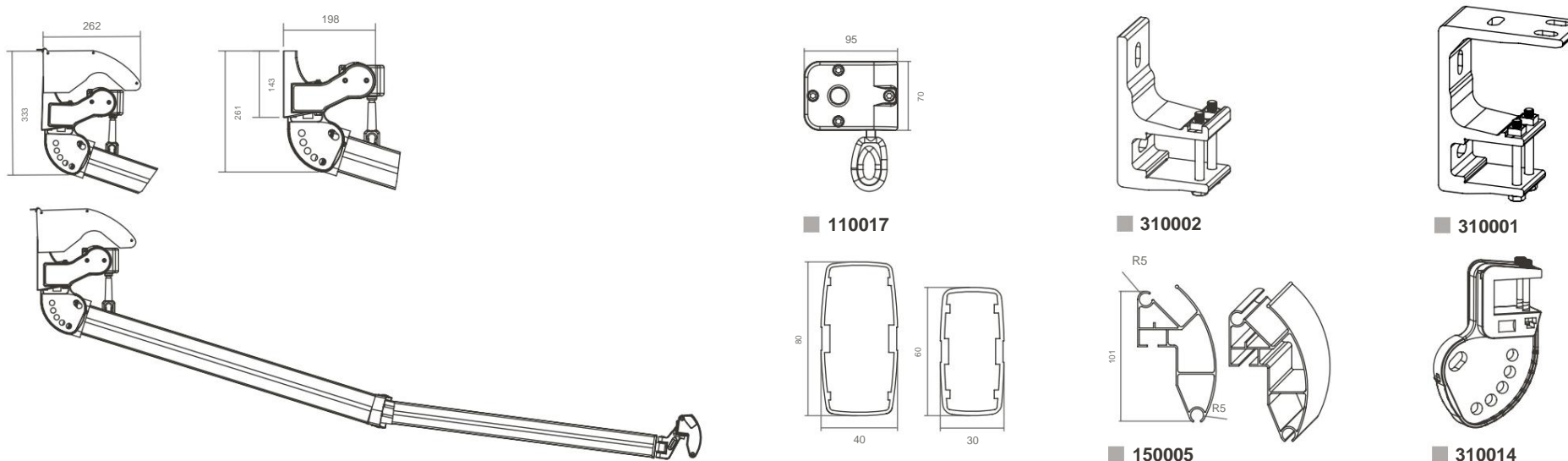

SCARICAMENTO / PROIEZIONE	ASSE / ASSE								
	3.00	3.50	4.00	4.50	5.00	5.50	6.00	6.50	7.00
2.00	€901 ↗	€966 ↗	€ 1.068 ↗	€1.142 ↗	€ 1.208 ↗	€ 1.294 ↘	€ 1.491 ↘	€ 1.567 ↘	€ 1.632 ↘
2.25	€941 ↗	€1.012 ↗	€ 1.118 ↗	€1.198 ↗	€ 1.268 ↗	€ 1.359 ↘	€ 1.565 ↘	€ 1.646 ↘	€ 1.716 ↘
2.50	€1.031 ↗	€1.106 ↗	€ 1.218 ↗	€ 1.302 ↗	€ 1.377 ↗	€ 1.473 ↘	€ 1.585 ↘	€ 1.798 ↘	€ 1.873 ↘
2,75	€ 1.073 ↘	€ 1.152 ↘	€ 1.269 ↘	€ 1.358 ↘	€ 1.438 ↘	€ 1.539 ↘	€ 1.655 ↘	€ 1.877 ↘	€ 1.957 ↘
3.00	-	€1.198 ↘	€ 1.319 ↘	€ 1.413 ↘	€ 1.498 ↘	€ 1.604 ↘	€1.725 ↘	€1.956 ↘	€2.041 ↘
3.25	-	-	€ 1.370 ↘	€ 1.469 ↘	€ 1.558 ↘	€ 1.669 ↘	€ 1.795 ↘	€2.035 ↘	€2.124 ↘
3.50	-	-	-	€ 1.525 ↘	€ 1.620 ↘	€ 1.735 ↘	€ 1.866 ↘	€2.115 ↘	€2.209 ↘

BEAUFORT

°4 °5 °6 ↘ ↗

I PREZZI NON INCLUDONO LA COPERTURA

I PREZZI NON INCLUDONO LA COPERTURA

I PREZZI NON INCLUDONO INSTALLAZIONE E IVA.

I PREZZI NON INCLUDONO INSTALLAZIONE E IVA

IL PREZZO È PER LA GESTIONE

IL PREZZO SI RIFERISCE AL COMANDO MANUALE

TENDA DA SOLE CLIENTE -10% SUL

LISTINO

TESSUTO PER TENDE DA SOLE DEL CLIENTE -10%

SUL LISTINO PREZZI

**VERNICE RAL 20% SUL
LISTINO PER SCELTA DIVERSA
DAL BIANCO RAL STANDARD**

VERNICE RAL 20% SUL PREZZO DI LISTINO
PER SELEZIONE FUORI DAL BIANCO RAL
COLORE STANDARD



BAR 40X40 CAPANNONE COPERCHIO BARRA 40X40

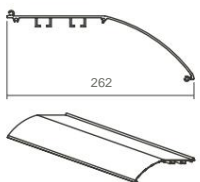
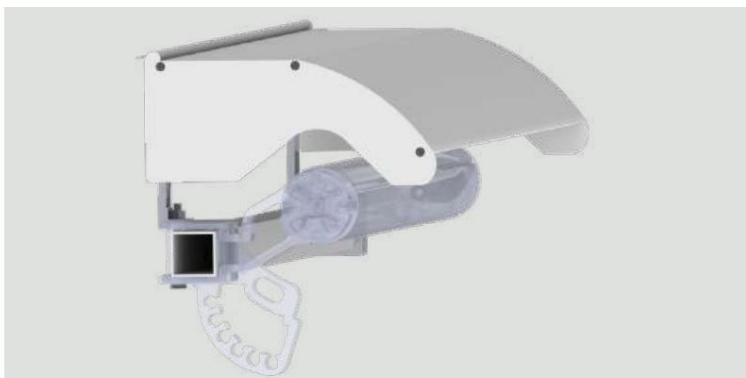

■ 310100

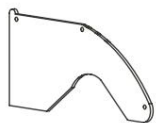

■ 310103

SISTEMA FLESSIBILE
MOVIMENTO INDIPENDENTE DELLA TENDA
INDIVIDUO FLESSIBILE
SISTEMA DI TENDE DA SOLE MOBILI

SISTEMA FLESSIBILE
TENDE DA SOLE A MOVIMENTO SINGOLO
COMBINATO FLESSIBILE
SISTEMA DI TENDE DA SOLE MOBILI

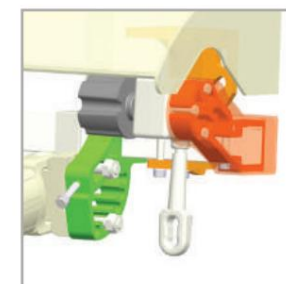
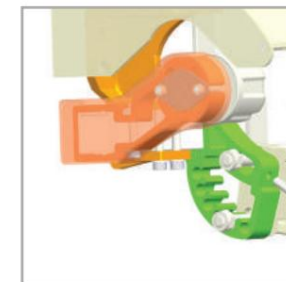
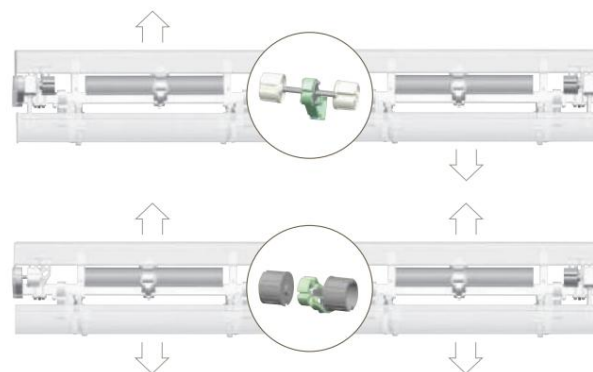

BASIS DI SUPPORTO	LUNGHEZZA DELL'ASSE				
	3M	4 milioni	5 milioni	6 milioni	7 milioni
2 PEZZI / 2 PEZZI	€136				
3 PEZZI / 3 PEZZI		€175	€215		
4 PEZZI / 4 PEZZI				€254	€294



GARANZIA
5 ANNI
GARANZIA



MOVIMENTO



COLORE STANDARD



VERNICE RAL 25% SUL LISTINO PER SCELTA DIVERSA DAL BIANCO RAL STANDARD

VERNICE RAL 25% SUL LISTINO PREZZI PER SELEZIONE FUORI DAL COLORE STANDARD BIANCO RAL

TABELLA DELLE SPECIFICHE

TABELLA DELLE SPECIFICHE

LUNGHEZZA DEL BRACCIO / LUNGHEZZA DEL BRACCIO	LUNGHEZZA DELL'ASSE								
	3.00	3.50	4.00	4.50	5.00	5.50	6.00	6.50	7.00
1,60	● ● ●	● ● ●	● ● ● ●	● ● ● ●	● ● ● ●	● ● ● ● ●	● ● ● ● ●	● ● ● ● ●	● ● ● ● ● ●
1,80	● ● ●	● ● ●	● ● ● ●	● ● ● ●	● ● ● ●	● ● ● ● ●	● ● ● ● ●	● ● ● ● ●	● ● ● ● ● ●
2.00	● ● ●	● ● ●	● ● ● ●	● ● ● ●	● ● ● ●	● ● ● ● ●	● ● ● ● ●	● ● ● ● ●	● ● ● ● ● ●
2.25	● ● ●	● ● ●	● ● ● ●	● ● ● ●	● ● ● ●	● ● ● ● ●	● ● ● ● ●	● ● ● ● ●	● ● ● ● ● ●
2.50	● ● ●	● ● ●	● ● ● ●	● ● ● ●	● ● ● ●	● ● ● ● ●	● ● ● ● ●	● ● ● ● ●	● ● ● ● ● ●
2,75		● ● ●	● ● ● ●	● ● ● ●	● ● ● ●	● ● ● ● ●	● ● ● ● ●	● ● ● ● ●	● ● ● ● ● ●
3.00		● ● ●	● ● ● ●	● ● ● ●	● ● ● ●	● ● ● ● ●	● ● ● ● ●	● ● ● ● ●	● ● ● ● ● ●
3.25			● ● ● ●	● ● ● ●	● ● ● ●	● ● ● ● ●	● ● ● ● ●	● ● ● ● ●	● ● ● ● ● ●
3.50				● ● ● ●	● ● ● ●	● ● ● ●	● ● ● ● ●	● ● ● ● ●	● ● ● ● ● ●

● BASI DI SUPPORTO

● PER BRACCI

TAVOLA CON ASSE PIÙ PICCOLO

TABELLA DELLE LUNGHEZZE MINIME DEGLI ASSI

SISTEMI / SISTEMI	LUNGHEZZA DEL BRACCIO									
	1,50	1,60	1,80	2.00	2.25	2.50	2,75	3.00	3.25	3.50
BARA SWIFT I	1,90 m	2,04 m	2,18 m	2,45 m	2,68 m	2,94 m	3,18 m	3,45 m	-	-
BARA SWIFT II	-	-	2,25 m	2,50 m	2,80 m	3,00 metri	3,30 m	3,56 m	3,80 m	4,10 m

I PREZZI NON INCLUDONO INSTALLAZIONE E IVA.

I PREZZI NON INCLUDONO INSTALLAZIONE E IVA

PERGOLE LYDIA PERGOLA LYDIA

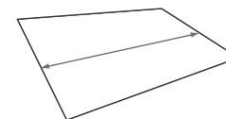
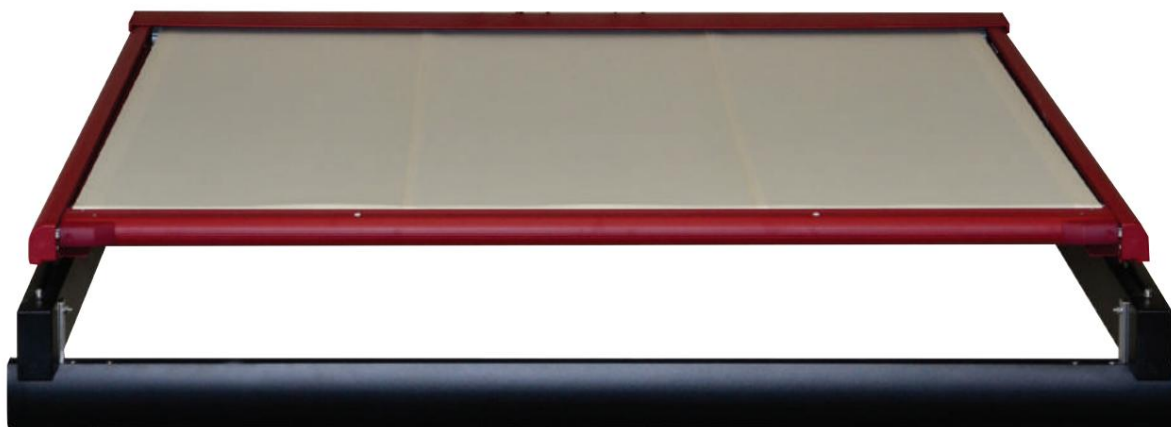

LUNGHEZZA
MIN 2,00 M / MAX 6,00 M

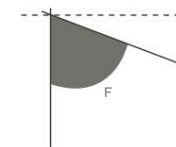

VISUALIZZA ESTENSIONE
MIN 30°

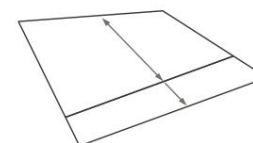

SCARICA PROIEZIONE
MIN 1,50 M / MAX 4,00 M



MOVIMENTO

COLORI STANDARD



LUCENTEZZA



ZABULINO DI ZIMIRELLA



DETTAGLI TECNICI - RICAMBI

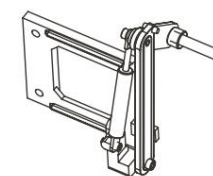
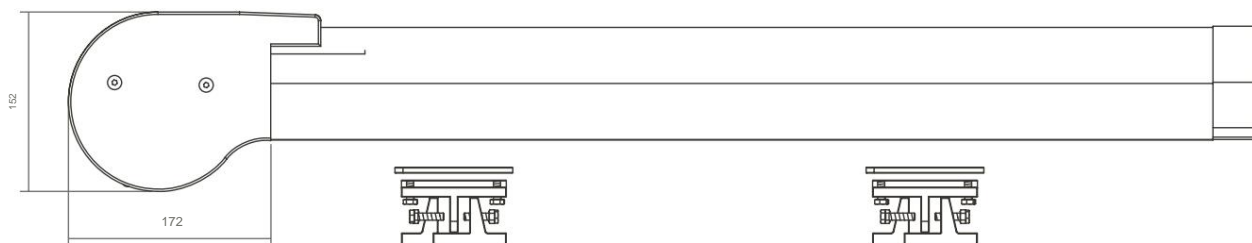

■ 350025

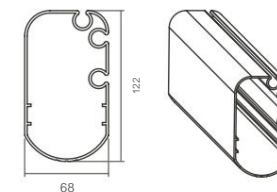

■ 350004

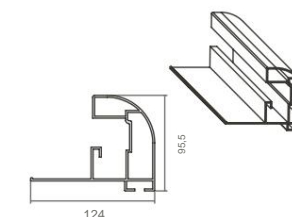

■ 350002

SCARICAMENTO / PROIEZIONE	ASSE / ASSE								
	2.00	2.50	3.00	3.50	4.00	4.50	5.00	5.50	6.00
1,50	€ 1.942	€2.025	€2.109	€2.192	€2.276	€2.360	€2.443	€2.527	€2.611
2.00	€2.027	€2.120	€2.214	€2.307	€2.400	€2.494	€2.587	€2.681	€2.774
2.50	€2.112	€2.215	€2.318	€2.422	€2.525	€2.628	€2.731	€2.835	€2.938
3.00	€2.197	€2.310	€2.423	€2.536	€2.649	€2.762	€2.875	€2.989	€3.102
3.50	€2.282	€2.405	€2.528	€2.651	€2.774	€2.897	€ 3.019	€ 3.142	€ 3.265
4.00	€2.367	€2.500	€2.633	€2.765	€2.898	€3.031	€ 3.164	€ 3.296	€ 3.429

IL PREZZO INCLUDE UN MOTORE CORDLESS
IL PREZZO INCLUDE IL MOTORE WIRELESS

I PREZZI NON INCLUDONO INSTALLAZIONE E IVA.
I PREZZI NON INCLUDONO INSTALLAZIONE E IVA

TENDA DA SOLE CLIENTE -10% SUL
LISTINO

TESSUTO PER TENDE DA SOLE DEL CLIENTE -10%
SUL LISTINO PREZZI



VERNICE RAL 15% DI SCONTO
SUL LISTINO PER SCELTE FUORI DAI
7 STANDARD

VERNICE RAL 15% SUL PREZZO DI LISTINO
PER LA SELEZIONE TRA 7 STANDARD
COLORI

CAPOTINES

SISTEMA DI TENDE A TENDALINO



■ K 02



■ K 03



■ K 04



■ K 05



■ K 06



■ K 07

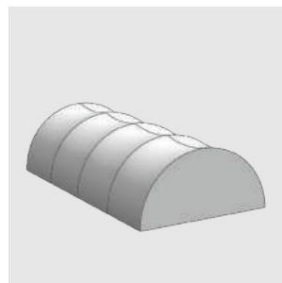

■ T 11



■ T 12

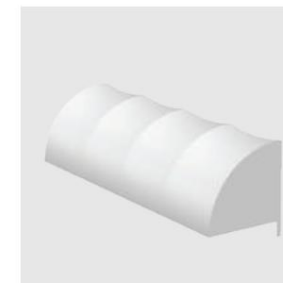

■ T 13



MOVIMENTO



COLORE STANDARD



TESSUTI TECNICI



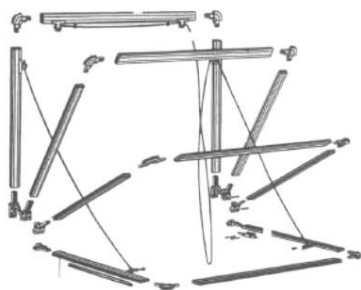

AKT. / RAGGIO	ASSE / ASSE															
	1,00	1,25	1,50	1,75	2,00	2,25	2,50	2,75	3,00	3,25	3,50	3,75	4,00	4,50	5,00	5,50
0,60	€265	€277	€288	€300	€312	€324	€335	€347	€359	€370	€382	€394	€406	€429	€452	€476
0,70	€276	€288	€301	€313	€325	€337	€349	€361	€373	€385	€398	€410	€422	€446	€470	€495
0,80	€288	€300	€313	€326	€338	€351	€363	€376	€388	€401	€413	€426	€438	€464	€489	€514
0,90	€300	€313	€326	€339	€352	€365	€378	€391	€404	€417	€430	€443	€456	€481	€507	€533
1,00	€312	€326	€339	€352	€366	€379	€392	€406	€419	€433	€446	€459	€473	€500	€526	€553
1,10	€325	€339	€352	€366	€380	€394	€408	€421	€435	€449	€463	€477	€491	€518	€546	€573
1,20	€338	€352	€366	€380	€395	€409	€423	€437	€452	€466	€480	€494	€509	€537	€566	€594
1,30	€351	€366	€380	€395	€410	€424	€439	€454	€468	€483	€498	€512	€527	€556	€586	€615
1,40	€365	€380	€395	€410	€425	€440	€455	€470	€485	€500	€515	€531	€546	€576	€606	€636
1,50	€379	€394	€410	€425	€441	€456	€472	€487	€503	€518	€534	€549	€565	€596	€627	€658

I PREZZI IN TABELLA SONO STATI CALCOLATI PER IL TIPO K01 CON COPERTURA IN PLASTICA NAIZIL E MOVIMENTO A CORDINO. COPERTURA CON PANNELLO TENDA SUPPLEMENTO DEL 30% SUL PREZZO DI LISTINO. GLI ALTRI TIPO K02 K03 K04 K05 K06 E K07 SONO SUPPLEMENTARI DEL 15% SUL PREZZO DI LISTINO.

I PREZZI PER I TIPI T11 T12 T13 VENGONO DETERMINATI DOPO CONSULTAZIONE.

I PREZZI DELLA TABELLA SONO CALCOLATI PER IL TIPO K01 CON PVC NAIZIL E MOVIMENTO A CORDINO.

PER LA SCELTA DEL TESSUTO DELLA TENDA DA SOLE, È APPLICABILE UN SUPPLEMENTO DEL 30% SUL PREZZO DI LISTINO. PER I TIPI K02 K03 K04 K05 E K07 È APPLICABILE UN SUPPLEMENTO DEL 15% SUL PREZZO DI LISTINO. I PREZZI PER I TIPI T11 T12 T13 SONO DEFINITI PREVIO ACCORDO.

IL MECCANISMO CON MECCANISMO A STELLA AD ANELLO LUNGO NON INCLUSO NEL PREZZO.

IL SET CON MOTORE SOMFY È A PAGAMENTO EXTRA.

IL KIT MECCANISMO A STELLA CON NODO LUNGO NON È INCLUSO NEL PREZZO.

IL SET MOTORE SOMFY È SOVRAPPREZZO.

I PREZZI NON INCLUDONO INSTALLAZIONE E IVA.

I PREZZI NON INCLUDONO INSTALLAZIONE E IVA

SISTEMA ELETTRICO "TRIPLE MOTION" SISTEMA MOTORE ELETTRICO "TRIPLE MOTION"

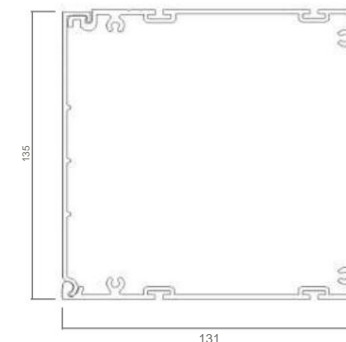
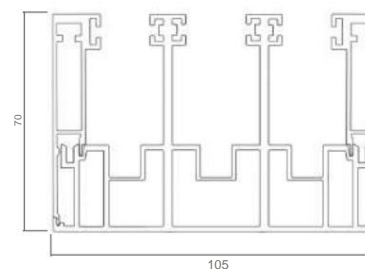
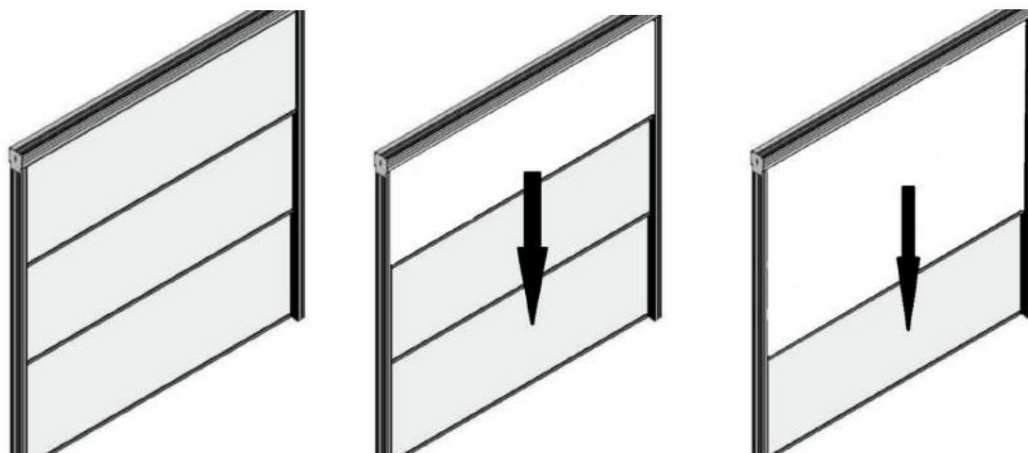

ALTEZZA / ALTEZZA	LUNGHEZZA				
	2.00	2.50	3.00	3.50	4.00
2.00	€ 3.320	€ 3.609	€ 3.927	€ 4.229	€ 4.531
2.50	€ 3.660	€ 4.003	€ 4.290	€ 4.684	€ 5.019
3.00	€ 4.008	€ 4.382	€ 4.760	€ 5.133	€ 5.507

IL PREZZO INCLUDE UN MOTORE CORDLESS

IL PREZZO INCLUDE IL MOTORE WIRELESS

I PREZZI NON INCLUDONO INSTALLAZIONE E IVA.

I PREZZI NON INCLUDONO INSTALLAZIONE E IVA

PER IL MOVIMENTO DAL BASSO VERSO L'ALTO, ADDEBITATO € 1000/PEZZO.

PER MOVIMENTO INVERSO DAL BASSO AL SU AGGIUNTA DI 1000 € / UNITÀ.



LUCENTEZZA

ZABULINO DI ZIMIRELLA

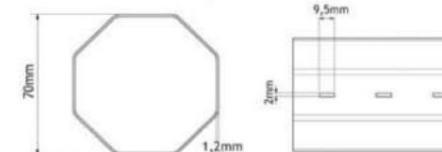
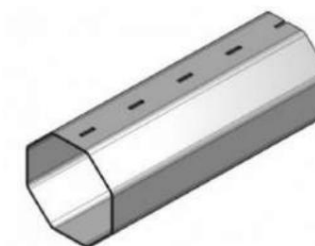

MOVIMENTO SENZA FILI



VERNICE RAL 8% SUL
LISTINO PER SCELTA FUORI DAI COLORI
STANDARD

VERNICE RAL 8% SUL PREZZO DI LISTINO PER
SELEZIONE DI COLORI FUORI STANDARD

SISTEMA MANUALE "SU E GIÙ"

SISTEMA MANUALE "SU E GIÙ"



ALTEZZA / ALTEZZA	LUNGHEZZA							
	1,50	1,75	2,00	2,25	2,50	2,75	3,00	3,25
1,80	€ 1.229	€ 1.341	€ 1.455	€ 1.565	€ 1.679	€ 1.791	€ 1.902	€2.014
2,00	€ 1.303	€ 1.420	€ 1.542	€ 1.664	€ 1.781	€ 1.902	€2.022	€2.144
2,20	€ 1.374	€ 1.499	€ 1.628	€ 1.758	€ 1.885	€2.014	€2.144	€2.271

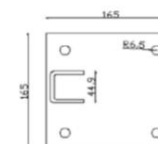
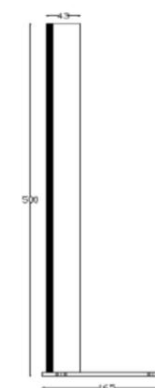
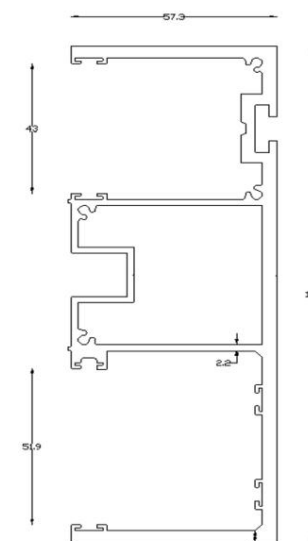

I PREZZI NON INCLUDONO INSTALLAZIONE E IVA.

I PREZZI NON INCLUDONO INSTALLAZIONE E IVA



LUCENTEZZA

COLORI STANDARD

ZABULINO DI ZIMIRELLA



VERNICE RAL 8% SUL
LISTINO PER SCELTA FUORI DAI COLORI
STANDARD

VERNICE RAL 8% SUL PREZZO DI LISTINO PER
SELEZIONE DI COLORI FUORI STANDARD

SISTEMA ELETTRICO "SU E GIÙ"

SISTEMA MOTORE ELETTRICO "MOVIMENTO SU E GIÙ"

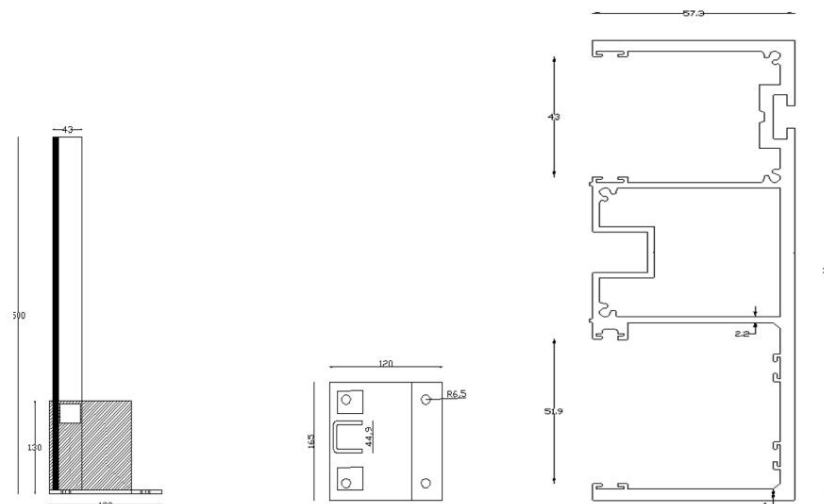

ALTEZZA / ALTEZZA	LUNGHEZZA				
	2.00	2.25	2.50	2,75	3.00
1,80	€2.350	€2.438	€2.527	€2.611	€2.700
2.00	€2.418	€2.510	€2.598	€2.692	€2.784
2.20	€2.482	€2.581	€2.682	€2.779	€2.878

IL PREZZO INCLUDE UN MOTORE CORDLESS

IL PREZZO INCLUDE IL MOTORE CABLATO

I PREZZI NON INCLUDONO INSTALLAZIONE E IVA.

I PREZZI NON INCLUDONO INSTALLAZIONE E IVA

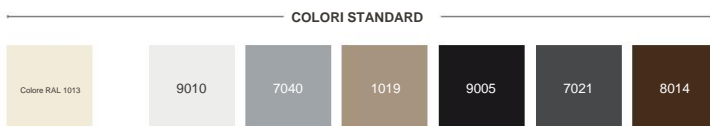

LUCENTEZZA

ZABULINO DI ZIMIRELLA



MOVIMENTO SENZA FILI



**VERNICE RAL 8% SUL
LISTINO PER SCELTA FUORI DAI
COLORI STANDARD**

**VERNICE RAL 8% SUL PREZZO DI LISTINO PER
SELEZIONE DI COLORI FUORI STANDARD**

FIORIERA PER SISTEMA "UP & DOWN" FIORIERA PER SISTEMA "UP & DOWN"

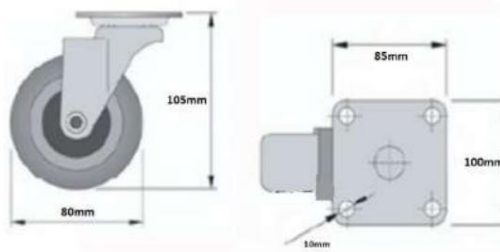
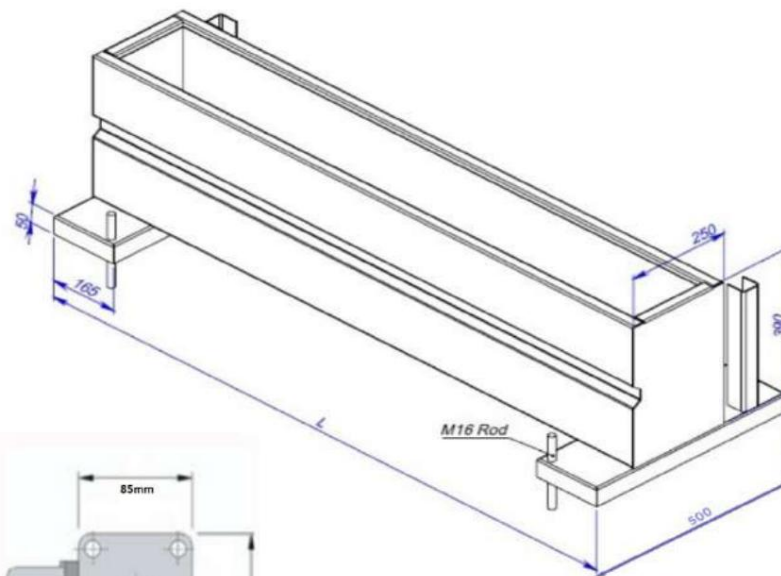

LUNGHEZZA		
2.00	2.50	3.00
€ 1.013	€ 1.199	€ 1.382

SET DI BASE E RUOTE EXTRA 332 €

SET FLANGE INFERIORI E RUOTE EXTRA €332

SI ADATTA SIA AL SISTEMA SALITA E DISCESA CON MOVIMENTO MANUALE CHE MOTORIZZATO
ADATTO A ENTRAMBI I SISTEMI SU E GIÙ MANUALE E MOTORE

I PREZZI NON INCLUDONO INSTALLAZIONE E IVA.

I PREZZI NON INCLUDONO INSTALLAZIONE E IVA

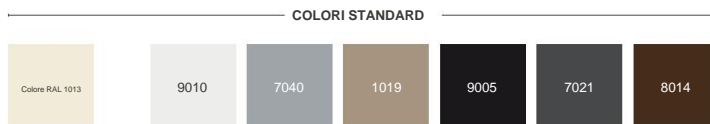

LUCENTEZZA

ZABULINO DI ZIMIRELLA



VERNICE RAL 8% SUL LISTINO
PER SCELTA FUORI DAI COLORI STANDARD

VERNICE RAL 8% SUL PREZZO DI LISTINO PER
SELEZIONE DI COLORI FUORI STANDARD

SISTEMA MANUALE "UP & DOWN PLUS"

SISTEMA MANUALE "UP & DOWN PLUS"



AGGIUNGERE L'OPZIONE FEGGIT
SCELTA DI AGGIUNGERE UN LUCE

ALTEZZA / ALTEZZA	LUNGHEZZA				
	1,50	2,00	2,50	3,00	3,50
2,00	€ 1.473	€ 1.715	€ 1.958	€2.200	€2.443
2,20	€ 1.560	€ 1.821	€2.080	€2.339	€2.598
2,40	€ 1.651	€ 1.925	€2.202	€2.477	€2.753

ALTEZZA / ALTEZZA	LUNGHEZZA				
	1,50	2,00	2,50	3,00	3,50
2,00	€213	€249	€302	€338	€445
2,20	€249	€302	€356	€391	€498
2,40	€302	€356	€409	€445	€569

I PREZZI NON INCLUDONO INSTALLAZIONE E IVA.

I PREZZI NON INCLUDONO INSTALLAZIONE E IVA

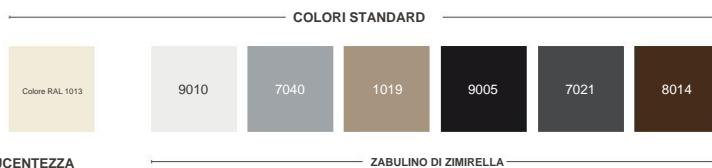

VERNICE RAL 8% SUL
LISTINO PER SCELTA FUORI DAI COLORI
STANDARD

VERNICE RAL 8% SUL PREZZO DI LISTINO PER
SELEZIONE DI COLORI FUORI STANDARD

SISTEMA MANUALE "SU E GIÙ PARIGI"

SISTEMA MANUALE "SU E GIÙ PARIGI"

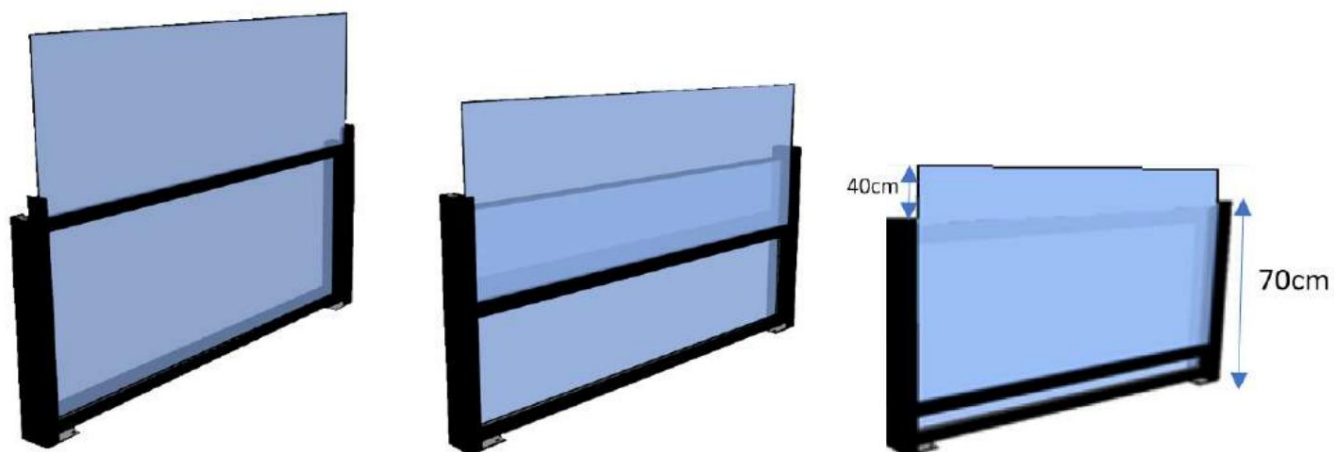

ALTEZZA / ALTEZZA	LUNGHEZZA				
	1,50	1,75	2,00	2,25	2,50
1,60	€ 1.387	€ 1.496	€ 1.613	€ 1.732	€ 1.852

IL VETRO MOBILE SULLA PARTE SUPERIORE È UN VETRO DI SICUREZZA SPESSO 8 MM
LA FINESTRA SUPERIORE MOBILE È SICURA CON 8 MM DI SPESSORE

I PREZZI NON INCLUDONO INSTALLAZIONE E IVA.

I PREZZI NON INCLUDONO INSTALLAZIONE E IVA



LUCENTEZZA

ZABULINO DI ZIMIRELLA



VERNICE RAL 8% SUL LISTINO
PER SCELTA FUORI DAI COLORI STANDARD

VERNICE RAL 8% SUL PREZZO DI LISTINO PER
SELEZIONE DI COLORI FUORI STANDARD

SISTEMA PARAVENTO FISSO

SISTEMA FRANGIVENTO FISSO

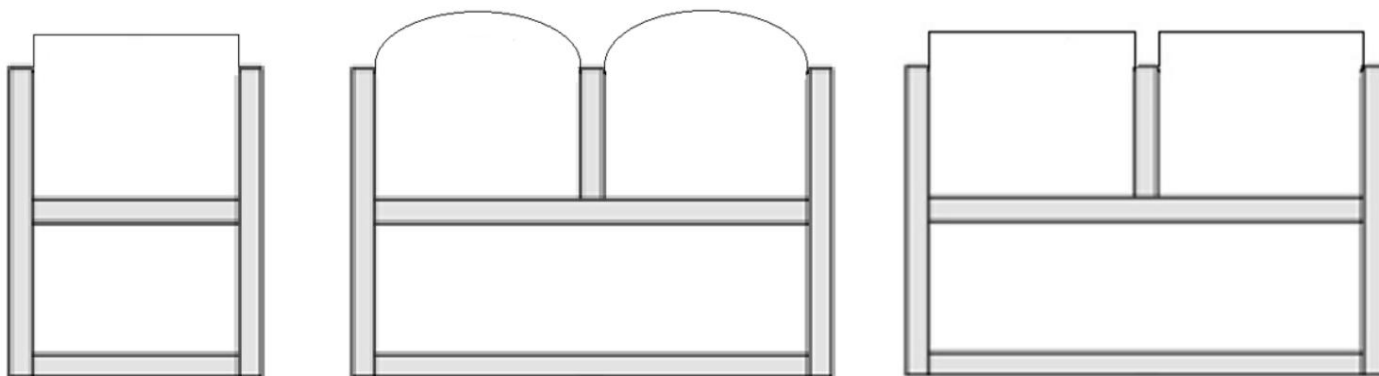

PREZZO AL METRO QUADRATO : 270 €/M2

PREZZO PER FINESTRE CURVE : €75

SCELTA DELLA LAMIERA AL POSTO DEL VETRO NELLA PARTE INFERIORE CON SOVRAPPREZZO DEL 7%

SCELTA DI POSIZIONARE LA LAMIERA SUL LATO INFERIORE INVECE DI FINESTRA CON EXTRA 7%

I PREZZI NON INCLUDONO INSTALLAZIONE E IVA.

I PREZZI NON INCLUDONO INSTALLAZIONE E IVA

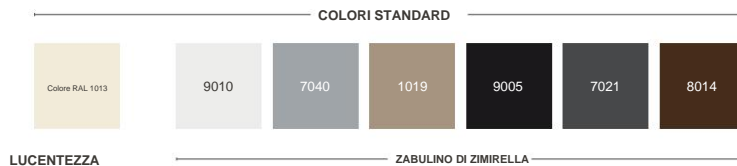

VERNICE RAL 8% SUL LISTINO PER SCELTA FUORI DAI COLORI STANDARD
VERNICE RAL 8% SUL PREZZO DI LISTINO PER SELEZIONE DI COLORI FUORI STANDARD

FIORIERA PER SISTEMA FISSO PARAVENTO

FIORIERA PER SISTEMA PARAVENTO STABILIZZATO

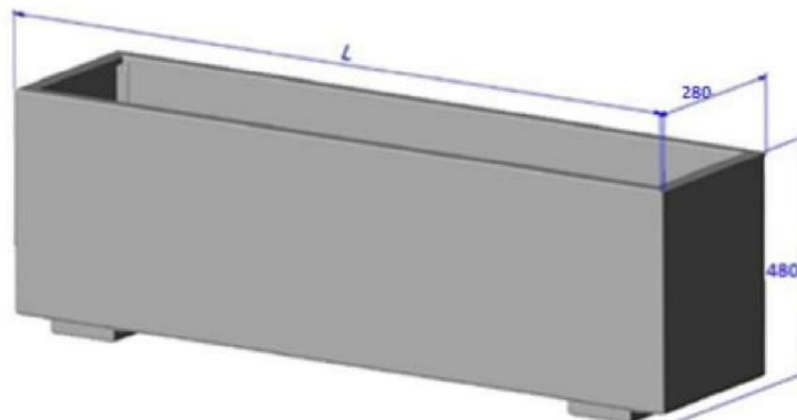

LUNGHEZZA	
1,00	1,50
€737	€889

I PREZZI NON INCLUDONO INSTALLAZIONE E IVA.
I PREZZI NON INCLUDONO INSTALLAZIONE E IVA



LUCENTEZZA



ZABULINO DI ZIMIRELLA

COLORI STANDARD



VERNICE RAL 8% SUL
LISTINO PER SCELTA FUORI DAI COLORI
STANDARD
VERNICE RAL 8% SUL PREZZO DI LISTINO PER
SELEZIONE DI COLORI FUORI STANDARD

PULIZIA E MANUTENZIONE

- Durante la manutenzione annuale, è necessario controllare il serraggio delle viti in tutto il sistema, in particolare dei tasselli, dei supporti e dei bulloni di fissaggio del sistema di ombreggiamento.
- Durante la manutenzione annuale, è necessario controllare il funzionamento e la lubrificazione delle parti mobili del sistema di ombreggiamento, ad esempio giunti dei bracci, perni dei cuscinetti, pinze, ecc. Si consiglia di utilizzare un materiale sintetico ad alta penetrazione in forma spray, a condizione che i componenti siano stati puliti.
- Controllare i cavi se il sistema è alimentato elettricamente.
- Per una migliore manutenzione delle vernici, si consiglia di pulirle regolarmente, in modo che mantengano le loro proprietà decorative e protettive.
- Il metodo di pulizia migliore è lavare frequentemente i profili verniciati con acqua tiepida e un detergente delicato. Tutte le superfici devono essere pulite solo con un panno morbido o una spugna.
- La frequenza della pulizia dipende dall'aspetto desiderato delle superfici verniciate, ma anche da fattori esogeni, quali:
 - La posizione geografica dell'edificio.
 - Livelli di inquinamento atmosferico.
 - Il vento.
 - La protezione dell'edificio da altri edifici (edificio denso o sparso).
 - La presenza di solidi nell'atmosfera (sabbia, polvere).
- In un ambiente inquinato (costiero, industriale, urbano con alti livelli di inquinamento) la pulizia dovrebbe essere effettuata almeno ogni 3 mesi, mentre per la campagna o l'ambiente urbano temperato la frequenza di pulizia può arrivare a 12 mesi, ma con un controllo ogni 6 mesi.

PULIZIA E MANUTENZIONE

- Durante la manutenzione annuale è necessario controllare tutte le viti a testa cilindrica del sistema e in particolar modo le viti che fissano il sistema tenda alla parete o al soffitto.
- Durante la manutenzione annuale è necessario effettuare un buon controllo della funzionalità e della lubrificazione delle parti mobili del sistema della tenda da sole.
- Controllo dei cavi in caso di impianto elettrico.
- Per una migliore conservazione del colore, consigliamo di pulire frequentemente i cavi, in modo che mantengano le loro caratteristiche decorative e protettive.
- Il modo migliore per pulire i profili verniciati a polvere è lavarli frequentemente con acqua tiepida e un detergente delicato. Tutte le superfici devono essere pulite con un panno morbido o una spugna.
- La frequenza di pulizia dei profili dipende dalle condizioni in cui si desidera mantenerli, ma anche da fattori esterni, come:
 - Posizione geografica dell'edificio.
 - Livello di inquinamento atmosferico.
 - Vento.
 - Protezione dell'edificio dagli edifici vicini (aree densamente popolate o non popolate).
 - Piccola concentrazione di particelle nell'aria.
- In un ambiente impegnativo (costiere, industriale, aree urbane con alti tassi di inquinamento), la pulizia dovrebbe essere programmata almeno ogni 3 mesi. In campagna o in un ambiente urbano temperato, la frequenza di pulizia potrebbe arrivare fino a 12 mesi, con controllo obbligatorio ogni 6 mesi.

CAMBIO DI COLORE

CAMBIO DI COLORE

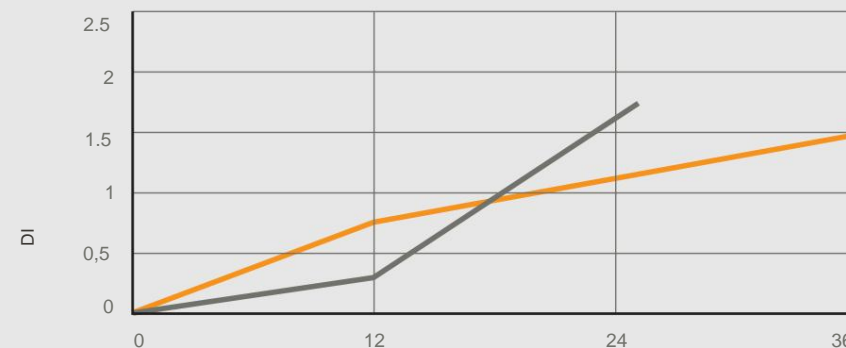

CONSERVAZIONE DELLA VETRATURA

CONSERVAZIONE DELLA LUCENTEZZA

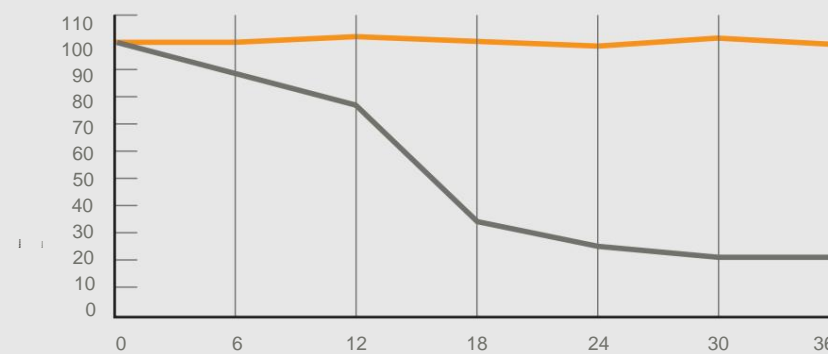

ESPOSIZIONE IN FLORIDA (MESI)

— INTERPON D2525 — POLIESTERE NORMALE

GARANZIA

GARANZIA

offre una garanzia di buona qualità per ogni prodotto che vende sul mercato.

- I meccanismi, i bracci e le cassette hanno una garanzia di 5 anni.
- I motori hanno la garanzia fornita dal produttore.
- Le plastiche e il parabrezza hanno una garanzia di 5 anni. Gli
- impianti Floper, Skyline e Formula hanno una garanzia di 5 anni.

Per i componenti venduti che compongono una tenda da sole, purché provengano tutti dal produttore FLOROS FINE SHADING, la nostra azienda offre una garanzia di 5 anni sul corretto funzionamento.

LA GARANZIA È VALIDA ALLE SEGUENTI CONDIZIONI:

- Che il sistema di ombreggiamento sia accompagnato dal documento di acquisto appropriato.
- Che il metodo di installazione del sistema sia quello previsto.
- Che la manutenzione e l'ispezione regolari vengano eseguite da un'officina autorizzata secondo le istruzioni del produttore (vedere il capitolo PULIZIA E MANUTENZIONE).
- Che il prodotto venga utilizzato correttamente (protezione da eventi meteorologici estremi, ad esempio nevicate, alluvioni, intensità del vento >6,7 Beaufort). Quando l'intensità del vento supera i 6,7 Beaufort, si consiglia di chiudere i bracci (chiudendo la tenda) dal centro verso l'alto, in modo da ridurre la superficie di pressione e, di conseguenza, la forza esercitata sulla tenda, per una migliore protezione e durata nel tempo.
- La chiusura e l'apertura della tenda (tessuto ombreggiante e visiera) vengono effettuate a condizione che sia completamente asciutta.

LA GARANZIA NON È VALIDA QUANDO:

- Le istruzioni di installazione, manutenzione e sicurezza del sistema non vengono rispettate. In caso di
- normale usura delle parti meccaniche.
- Quando si verifica la normale usura della vernice.
- Quando si verifica un cambiamento nel comportamento del gel in caso di variazione di Temperatura - Umidità - Radiazione.

offre un'eccellente garanzia di qualità per ogni prodotto.

- Meccanismi, bracci e cassette hanno una garanzia di 5 anni.
- I motori sono dotati di garanzia rilasciata dal produttore.
- I tessuti tecnici e il PVC trasparente hanno una garanzia di 5 anni.
- Anche i sistemi Floper, Skyline e Formula hanno una garanzia di 5 anni.

Per la vendita di parti che compongono un sistema di tende da sole, e se si tratta di prodotti del produttore FLOROS FINE SHADING, la nostra azienda offre una garanzia di eccellente funzionamento di 5 anni.

LA GARANZIA È VALIDA ALLE SEGUENTI CONDIZIONI:

- L'intero sistema di ombreggiatura è accompagnato dalla relativa documentazione di acquisto.
- Il processo di installazione è quello previsto.
- I prodotti installati vengono regolarmente conservati e controllati da un gruppo di assistenza autorizzato, secondo le istruzioni del produttore (vedere capitolo PULIZIA E MANUTENZIONE).
- Che il prodotto sia ben utilizzato (protezione da condizioni meteorologiche avverse, ad esempio neve, vento forte superiore a 6, 7 Beaufort). In caso di vento forte superiore a 6, 7 Beaufort, si consiglia di chiudere il braccio (chiusura della tenda) dal centro e dall'alto, in modo da ridurre la pressione esercitata sul sistema della tenda, per ottenere la migliore protezione e resistenza nel tempo.
- La chiusura-apertura della tenda (tessuto ombreggiante e PVC) viene effettuata a condizione che sia completamente asciutta.

LA GARANZIA NON È VALIDA SE:

- Le istruzioni di installazione, la manutenzione e la sicurezza del sistema non vengono rispettate.
- Quando si verificano normali danni alle parti meccaniche
- Quando c'è un normale danneggiamento del colore.
- Quando si verifica un cambiamento nelle condizioni del PVC in caso di alterazione della temperatura, umidità, radiazioni.

AVVERTENZE DI SICUREZZA

AVVERTENZE DI SICUREZZA

- Il montaggio e l'installazione devono essere eseguiti da personale qualificato.
- In caso di installazione di un sistema alimentato elettricamente, il sistema deve essere scollegato dall'alimentazione elettrica durante la manutenzione, la pulizia e la riparazione.
- In caso di installazione di un sistema azionato elettricamente, le istruzioni di sicurezza si trovano nell'inserto motore allegato al sistema.
- Il collegamento di un impianto elettrico deve essere effettuato da un elettricista autorizzato.
- I bracci sono imballati sotto tensione a molla. Attenzione: la loro sicurezza deve essere rimossa una volta completata l'installazione del sistema di tende da sole.
- I bracci e il contrappeso di un sistema di tende da sole si aprono e si chiudono. L'altezza di installazione e di funzionamento dei componenti della tenda da sole deve essere superiore a 2500 mm da terra.
- Durante l'apertura e la chiusura, assicurarsi che non vi siano ostacoli che possano interferire con il funzionamento. Non forzare mai il sistema.
- Quando si disimballa il sistema di tende da sole, fare attenzione a non tagliare il materiale ombreggiante (tessuto) e a non graffiare la vernice dei profili e degli accessori. Si consiglia di non utilizzare alcun tipo di coltello, ma solo forbici.
- Il montaggio e l'installazione devono essere effettuati da personale qualificato.
- Nel caso di installazioni motorizzate, durante le ispezioni di manutenzione o le riparazioni, il sistema deve essere scollegato dall'alimentazione elettrica.
- Nel caso di installazioni motorizzate, le istruzioni di sicurezza del motore sono riportate nel libretto del motore allegato al sistema.
- Il collegamento del sistema motorizzato deve essere effettuato esclusivamente da un elettricista abilitato.
- I bracci sono imballati sotto tensione a molla. ATTENZIONE: i fusibili di alimentazione devono essere rimossi dopo l'installazione dei sistemi di tende da sole.
- I bracci di flessione e la barra terminale di un sistema di tende da sole sono di tipo "open-close". L'altezza di installazione e di funzionamento dei componenti della tenda da sole deve essere di 2500 mm più alta da terra.
- Durante l'apertura e la chiusura, assicurarsi che non vi siano ostacoli che possano ostacolare il movimento. Non forzare mai il sistema.
- Quando si rimuove la tenda dall'imballaggio, assicurarsi di non tagliare il tessuto e di non graffiare i profili verniciati a polvere. Si consiglia di non utilizzare alcun tipo di coltello, ma solo forbici.

MODULI D'ORDINE
MODULI D'ORDINE

